

Reyem

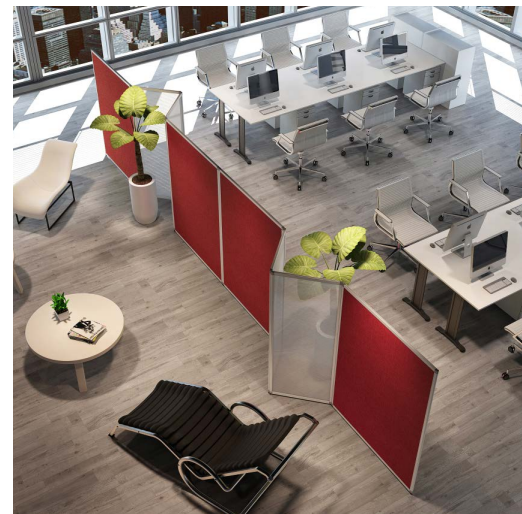

CLOISONNETTES
+SOLUTIONS ACOUSTIQUES



OFFICE SCREENS
+ACOUSTIC SOLUTIONS



STELLWÄNDE
+AKUSTISCHE LÖSUNGEN



Available on **pCon**
PLANNER

2025



2025

FABRICATION
FRANCAISE
DEPUIS 41 ANS

40% DE LA
PRODUCTION
EXPORTEE

VENTE
UNIQUEMENT
À DES
REVENDEURS



2025

MADE IN
FRANCE
FOR 41 YEARS

40% OF THE
PRODUCTION IS
EXPORTED

SALE TO
RESELLERS
ONLY



2025

FRANZÖSISCHE
PRODUKTION
SEIT 41 JAHREN

40% DER
ERZEUGNISSE
EXPORTIERT

VERKAUF NUR
AN HÄNDLER

Available on

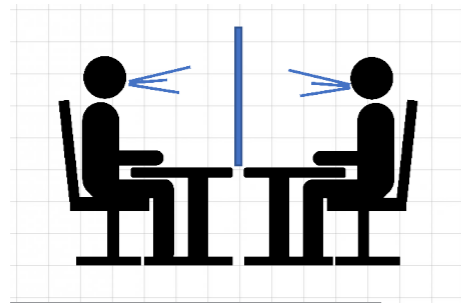

Protections COVID-19 **6**
 COVID-19 protections **& 25**
 COVID-19 Schutzwände

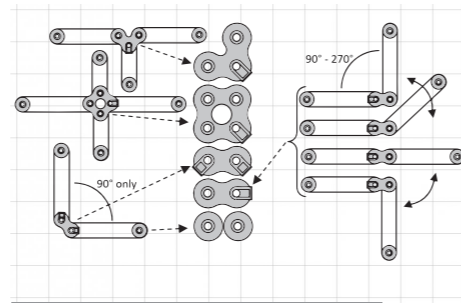

Système d'assemblage **8**
 Assembly system
 Montagesystem



Piètements & roulettes **30**
 Feet & castors
 Füße & Rollen

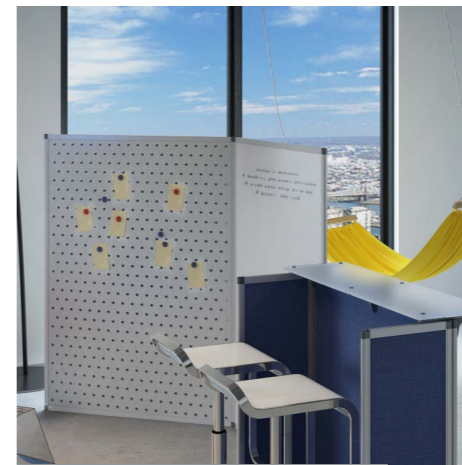

Tôle perforée magnétique **32**
 Magnetic perforated metal sheet
 Magnetisch Lochblech



Panneaux pour banque d'accueil **33**
 Panels for reception desk
 Wände für Empfangstheke



Mélaminé **10**
 Melamine
 Melamin



Tissu **14**
 Fabric
 Stoff



Acoustique **20**
 Acoustic
 Akustik



Postes de travail & Call Center **34**
 Workstations & Call center
 Arbeitsplätze & Call Center



Réhausse + écran en verre **38**
 Glass desk screen + topper
 Glaswände + Aufsatz



Accessoires **40**
 Accessories
 Zubehör



Super-Acoustique **22**
 Super-Acoustic
 Super-Akustik



Verre acrylique + Polycarbonate **24**
 Acrylic glass & Polycarbonate
 Acrylglas & Polycarbonat



Panneaux d'affichage magnétiques **28**
 Magnetic notice boards
 Magnetische Anschlagtafeln



Solutions acoustiques **42**
 Acoustic solutions
 Akustische Lösungen



Cloisons mobiles sur roulettes **44**
 Freestanding screens on castors
 Bewegliche Wände auf Rollen



Conditions de transport **46**
 Conditions of transport
 Beförderungsbedingungen

 **PROTECTIONS COVID-19**

 **COVID-19 PROTECTIONS**

 **COVID-19 SCHUTZWÄNDE**

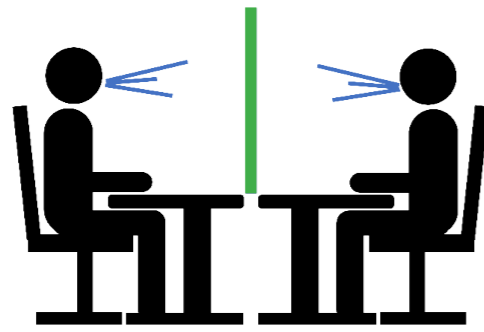

Voir pages 25-27

See pages 25-27

Siehe Seiten 25-27

Verre acrylique incolore 3 ou 4mm
Dimensions standards ou sur mesure

Dimensions **maximum** conseillées :
Epaisseur 3mm **Ref. PX3** : 800 x 800 mm
Epaisseur 4mm **Ref. PX4** : 1000x1000mm
Découpe sur mesure, veuillez nous consulter

3 or 4mm colourless acrylic glass
Standard or custom dimensions

Maximum dimensions:
3mm thick **Ref. PX3**: 800 x 800 mm
4mm thick **Ref. PX4**: 1000 x 1000mm
Cut to size, please contact us

3 oder 4mm Klaracrylglas
Standard- oder benutzerdefinierte Abmessungen

Maximale Abmessungen:
3mm dick **Ref. PX3**: 800 x 800 mm
4mm dick **Ref. PX4**: 1000 x 1000mm
Zuschnitt nach Maß, kontaktieren Sie uns

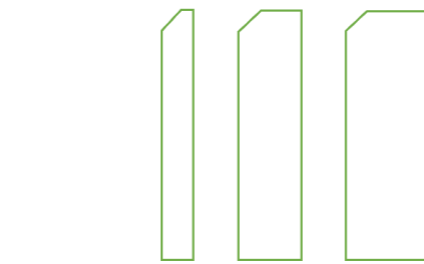

Hauteur
Height
Höhe

390 mm

- Ref. PX3 390 x 50
- Ref. PX4 390 x 50
- Ref. PX3 390 x 100
- Ref. PX4 390 x 100
- Ref. PX3 390 x 150
- Ref. PX4 390 x 150

590 mm

- Ref. PX3 590 x 50
- Ref. PX4 590 x 50
- Ref. PX3 590 x 100
- Ref. PX4 590 x 100
- Ref. PX3 590 x 150
- Ref. PX4 590 x 150



Hauteur
Height
Höhe

590 mm

- Ref. PX3 590 x 190
- Ref. PX4 590 x 190
- Ref. PX3 590 x 390
- Ref. PX4 590 x 390
- Ref. PX3 590 x 590
- Ref. PX4 590 x 590
- Ref. PX3 590 x 790
- Ref. PX4 590 x 790

790 mm

- Ref. PX3 790 x 190
- Ref. PX4 790 x 190
- Ref. PX3 790 x 390
- Ref. PX4 790 x 390
- Ref. PX3 790 x 590
- Ref. PX4 790 x 590
- Ref. PX3 790 x 790
- Ref. PX4 790 x 790

Connecteur
pour verre acrylique de 3 ou 4mm

Connector
for 3 or 4mm acrylic glass

Verbinder
für 3 oder 4mm Acrylglas



Ref. PLE 204



Ref. PLE 202



Ref. PLE 203



Ref. PLE 222

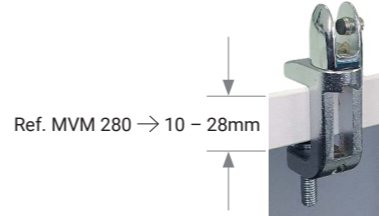
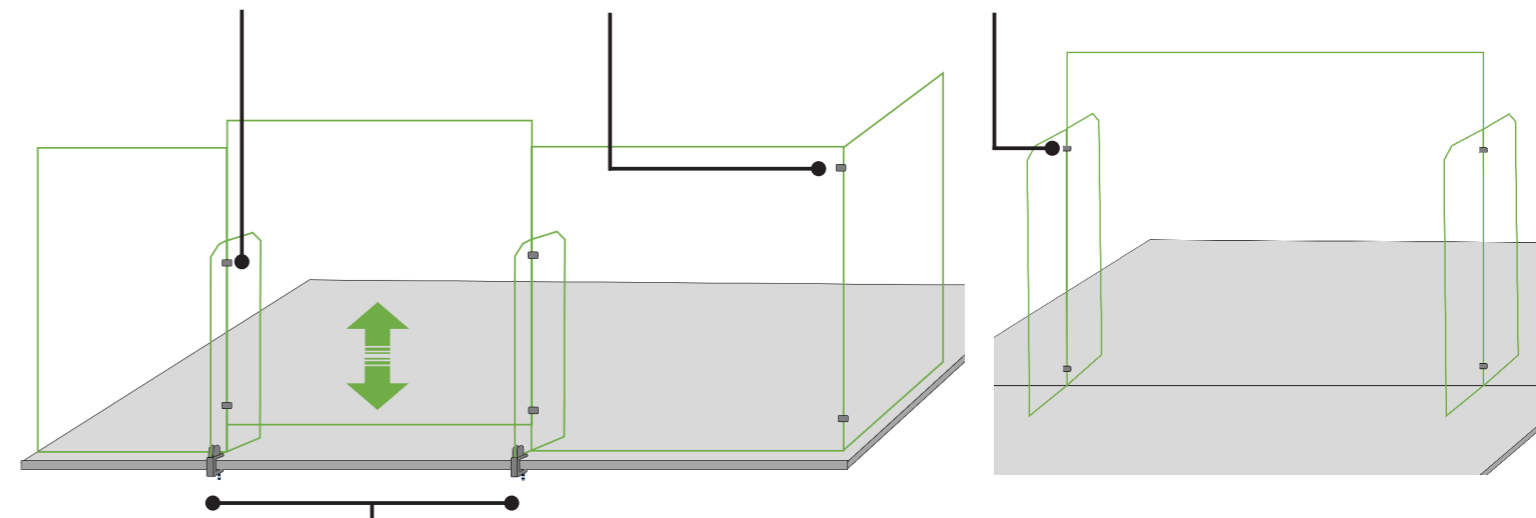

Ref. MVM 280 → 10 - 28mm

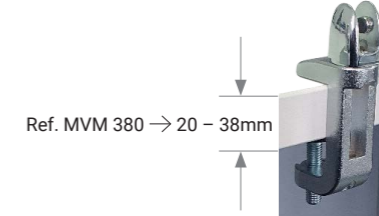

Ref. MVM 380 → 20 - 38mm

Ref. MVM 280

Ref. MVM 380

Pince bureau métallique
+ clip pour verre acrylique de 3 ou 4 mm

Metal desk clamp
+ clip for 3 or 4mm acrylic glass

Tischklammer
+ Klip für 3 oder 4mm Acrylglas

SYSTÈME D'ASSEMBLAGE

ASSEMBLY SYSTEM

MONTAGE-SYSTEM

FICHE TECHNIQUE

TECHNICAL DATA

TECHNISCHEN DATEN

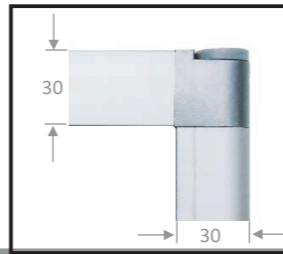
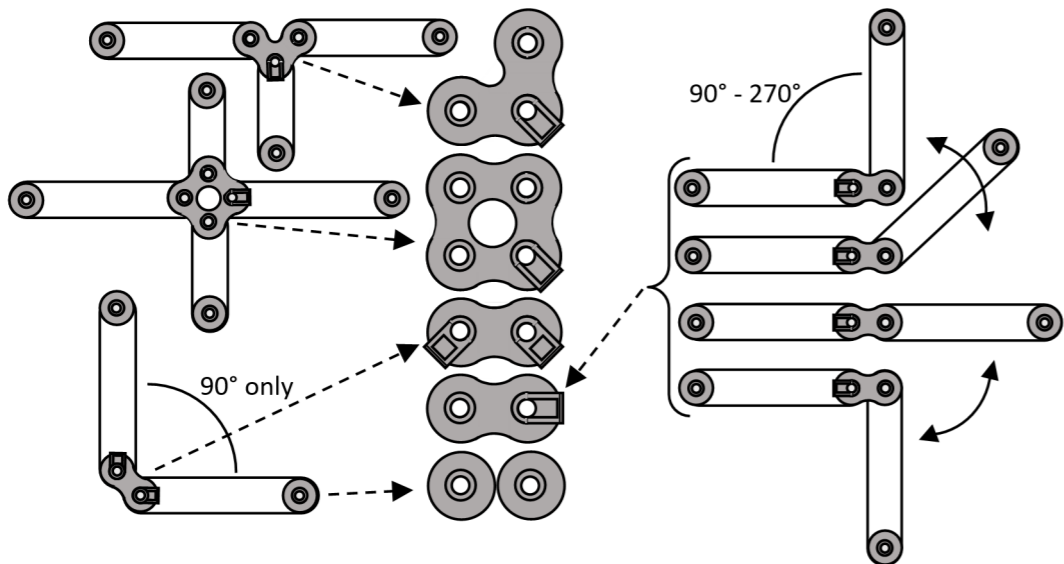
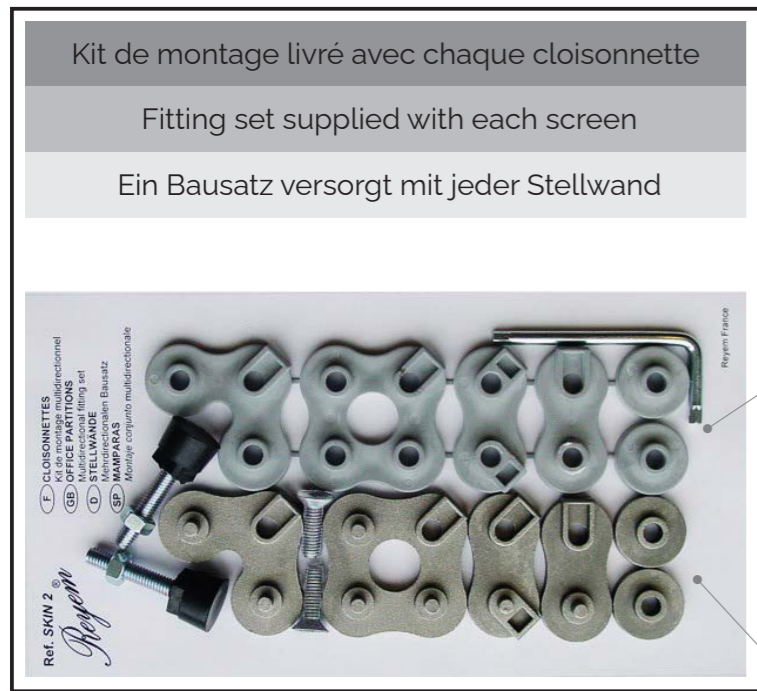
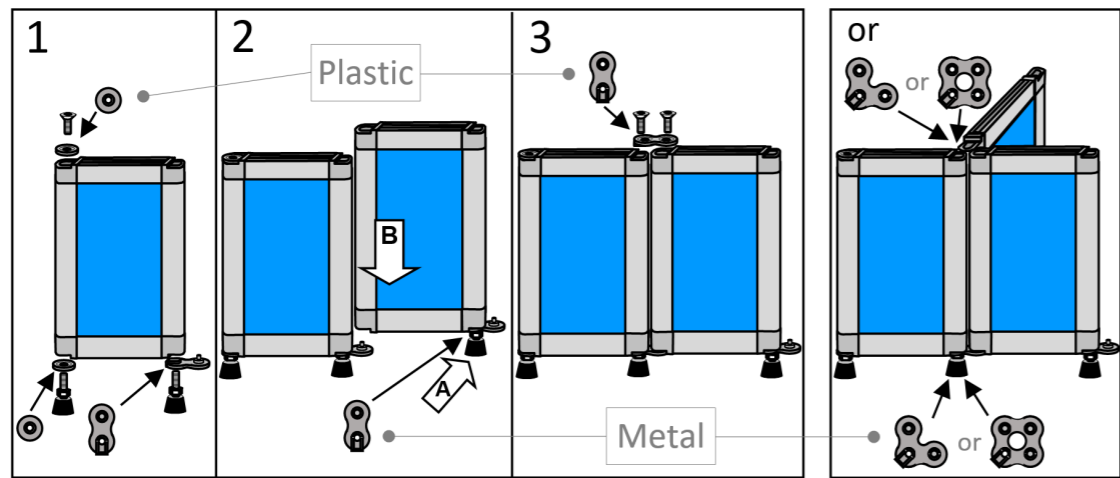

OSSATURE
Toutes les cloisons Reym sont fabriquées avec une ossature en aluminium anodisé nature de 30mm, d'épaisseur 22mm et assemblées avec des pièces d'angle en alliage de zinc, peinture liquide RAL 9006.

FRAME
Each Reym screen is made using a colourless, anodised aluminium frame of 30mm and 22mm thick. The frame is assembled with corner pieces made of a zinc alloy, liquid paint RAL 9006.

RAHMEN
Jede Reym-Wand wird mit einem 30mm und 22mm dicken Rahmen aus farblosem, eloxiertem Aluminium gefertigt. Der Rahmen wird mit zinklegierten Eckstücken, flüssige Farbe RAL 9006 zusammengesetzt.

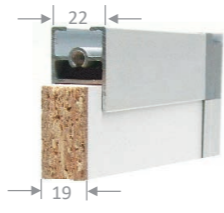

MELAMINE
Mélaminé d'épaisseur 19mm, classement au feu M3 / D, s2, d0. Classement au feu M1 / B, s2, d0 possible, veuillez nous consulter pour prix et délais. Coloris page 11

MELAMINE
19mm thick melamine, fire safety classification: D, s2, d0. Fire safety classification B, s2, d0 possible, please contact us for price and delivery time. Colours page 11

MELAMIN
19mm Melamin, Feuersicherung: D, s2, d0. Feuersicherung B, s2, d0 möglich, bitte kontaktieren Sie uns für Preis und Lieferzeit. Melaminfarben Seite 11

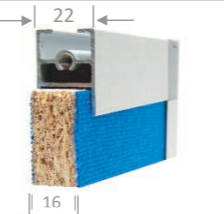

TISSU
Aggloméré de 16mm 100% PEFC et FSC
+ Colle à l'eau
+ Textile (voir page 15)
Tests acoustiques page 17

FABRIC
16mm thick chipboard 100% PEFC et FSC
+ Water glue
+ Textile (see page 15)
Acoustic tests page 17

STOFF
16mm Spanplatten 100% PEFC- und FSC-zertifiziert
+ Wasser-Leim
+ Textil (siehe Seite 15)
Akustikteste Seite 17

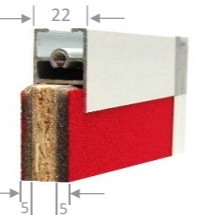

ACOUSTIQUE
Aggloméré de 10mm 100% PEFC et FSC
+ 2 x 5mm de mousse 100% polyuréthane, densité 23 kg/m3
+ Colle à l'eau
+ Textile (voir page 15)
Tests acoustiques page 17

ACOUSTIC
10mm thick chipboard 100% PEFC et FSC
+ 2 x 5mm foam 100% polyurethane, density 23 kg/m3
+ Water glue
+ Textile (see page 15)
Acoustic tests page 17

AKUSTIK
10mm Spanplatten 100% PEFC- und FSC-zertifiziert
+ 2 x 5mm Schaum 100% Polyurethan, Dichte 23 kg/m3
+ Wasser-Leim
+ Textil (siehe Seite 15)
Akustikteste Seite 17

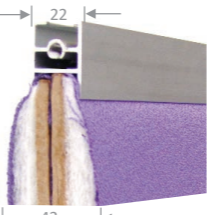

SUPER-ACOUSTIQUE
2 x 5mm de Medium Density Fibreboard (MDF)
+ 2 x 15mm de fibre 100% polyester, densité 30 kg/m3
+ Textile (voir page 15)
Tests acoustiques page 17

SUPER-ACOUSTIC
2 x 5mm thick Medium Density Fibreboard (MDF)
+ 2 x 15mm 100% polyester fibre, density 30 kg/m3
+ Textile (see page 15)
Acoustic tests page 17

SUPER-AKUSTIK
2 x 5mm Medium Density Fibreboard (MDF)
+ 2 x 15mm 100% Polyesterfaser, Dichte 30 kg/m3
+ Textil (siehe Seite 15)
Akustikteste Seite 17

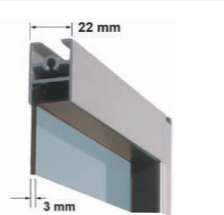

VERRE ACRYLIQUE
Finition verre acrylique 3mm. Incolore, fumé gris, ou opale, résistance durable aux UV, classement feu M4 / E.
+ Profilé de compensation en PVC noir

ACRYLIC GLASS
3mm thick acrylic glass. Colourless, gray tinted or opal, long-lasting UV resistance, fire safety classification: E.
+ compensator profile made of black PVC

ACRYLGLAS
3mm Acrylglas, Klar, grau Rauch oder Opal. Langlebig UV-beständig, Feuersicherung: E.
+ Kompensator Profil schwarz PVC



POLYCARBONATE ALVÉOLAIRE
Finition polycarbonate alvéolaire incolore 6mm. Protection UV par coextrusion, classement au feu M1 / B, s1, d0
+ Profilé de compensation en PVC

ALVEOLAR POLYCARBONATE
6mm thick colourless alveolar polycarbonate. UV protection by coextrusion, fire classification: B, s1, d0
+ compensator profile made of black PVC

POLYCARBONAT
6mm Klarpolycarbonat. UV-beständigkeit (Coextrusion), Feuersicherung Class B, s1, d0.
+ Kompensator Profil schwarz PVC

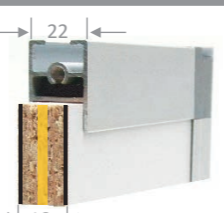

AFFICHAGE MAGNÉTIQUE
Face magnétique émaillée blanche (disponible en 1 ou 2 faces)

MAGNETIC NOTICE BOARDS
Enameled white magnetic side (available on 1 or 2 sides)

MAGNETISCHE ANSCHLAGTAFELN
Emailliert weiß magnetisch Seite (Verfügbar auf 1 oder 2 Seiten)



MÉLAMINÉ



MELAMINE



MELAMIN

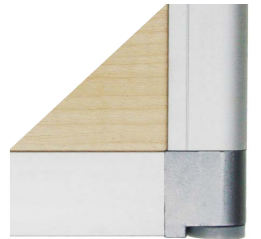

Mé laminé d'épaisseur 19mm, fibre du bois horizontal (Epaisseur 8mm possible, voir page 45). 100% PEFC et FSC.

19mm thick melamine, wood fiber horizontal (8mm thick melamine possible, see page 45). 100% PEFC and FSC.

19mm Melamin, Waagrecht Holzfase (8mm Melamin möglich, siehe Seite 45). 100% PEFC- und FSC-zertifiziert.



Noyer
Walnut wood
Nussbaum



H 3734



U 963



U 113

Hêtre
Beech
Buche



H 1582



U 732

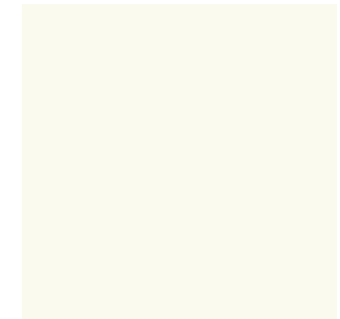

110 M

Erable
Maple
Ahorn



375 M



U 708



U 500

Pour un classement au feu M1 / B, s2, d0, d'autres mélaminés ou coloris, veuillez nous consulter.

Les photographies des mélaminés sont présentées à titre indicatif. Des variations de couleurs peuvent se produire. Nous vous conseillons de demander de vrais échantillons.

For B, s2, d0 fire safety classification, other melamine or colour finishes, please contact us.

The photographs of the melamine finishes are shown as a guideline only. Colours may vary. We recommend that you ask for samples before ordering.

Bei Fragen bezüglich der Brandschutzklasseneinstufung B, s2, d0, anderen Melaminbeschichtungen oder Farbtönen wenden Sie sich an uns.

Die Abbildungen der Melaminbeschichtungen sind unverbindlich. Es können Farbabweichungen auftreten. Wir empfehlen Ihnen, echte Probemuster anzufordern.

**CLOISONNETTE
MÉLAMINÉ**

**MELAMINE
SCREEN**

**MELAMIN-
STELLWAND**

Kit de montage livré avec chaque cloisonnette
Fitting set supplied with each screen
Ein Bausatz versorgt mit jeder Stellwand

Hauteur Height Höhe	1200 mm	1400 mm	1600 mm	1800 mm
	Ref. MMM 1200 x 610 Ref. MMM 1200 x 810 Ref. MMM 1200 x 1010 Ref. MMM 1200 x 1210 Ref. MMM 1200 x 1410 Ref. MMM 1200 x 1610	Ref. MMM 1400 x 610 Ref. MMM 1400 x 810 Ref. MMM 1400 x 1010 Ref. MMM 1400 x 1210 Ref. MMM 1400 x 1410 Ref. MMM 1400 x 1610	Ref. MMM 1600 x 610 Ref. MMM 1600 x 810 Ref. MMM 1600 x 1010 Ref. MMM 1600 x 1210 Ref. MMM 1600 x 1410 Ref. MMM 1600 x 1610	Ref. MMM 1800 x 610 Ref. MMM 1800 x 810 Ref. MMM 1800 x 1010 Ref. MMM 1800 x 1210 Ref. MMM 1800 x 1410 Ref. MMM 1800 x 1610

Avec verre acrylique 3mm ou polycarbonate alvéolaire 6mm
With 3mm acrylic glass or 6mm alveolar polycarbonate
Mit 3mm Acrylglas oder 6mm Klarpolycarbonat

Ref. ___ 1200 x 610 Ref. ___ 1200 x 810 Ref. ___ 1200 x 1010 Ref. ___ 1200 x 1210 Ref. ___ 1200 x 1410 Ref. ___ 1200 x 1610	Ref. ___ 1400 x 610 Ref. ___ 1400 x 810 Ref. ___ 1400 x 1010 Ref. ___ 1400 x 1210 Ref. ___ 1400 x 1410 Ref. ___ 1400 x 1610	Ref. ___ 1600 x 610 Ref. ___ 1600 x 810 Ref. ___ 1600 x 1010 Ref. ___ 1600 x 1210 Ref. ___ 1600 x 1410 Ref. ___ 1600 x 1610	Ref. ___ 1800 x 610 Ref. ___ 1800 x 810 Ref. ___ 1800 x 1010 Ref. ___ 1800 x 1210 Ref. ___ 1800 x 1410 Ref. ___ 1800 x 1610
--	--	--	--



Ref. MMJ	Ref. MMG	Ref. MML	Ref. MMP
Incolore	Fumé gris	Opale	Polycarbonate alvéolaire incolore Classement feu M1 / B, s1, d0
Colourless	Gray tinted	Opal	Clear alveolar polycarbonate Fire safety classification B, s1, d0
Klar	Grau Rauch	Opal	Klarpolycarbonat Feuersicherung Class B, s1, d0



Ref. MVP 300
Pied sur platine plate
Prix unitaire
Foot on flat plate
Unit price
Fuß auf flacher Platte
Stückpreis

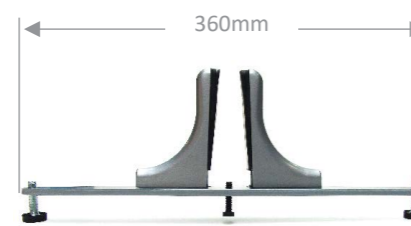

Ref. MVP 360
Pied Réglable
Prix unitaire
Adjustable foot
Unit price
Verstellbarer Fuß
Stückpreis

**ÉCRAN DE BUREAU
MÉLAMINÉ**

**MELAMINE
DESK SCREEN**

**MELAMIN-
TISCH-TRENNWAND**

Hauteur Height Höhe	400 mm	600 mm	800 mm
	Ref. MMB 400 x 800 Ref. MMB 400 x 1000 Ref. MMB 400 x 1200 Ref. MMB 400 x 1400 Ref. MMB 400 x 1600 Ref. MMB 400 x 1800	Ref. MMB 600 x 800 Ref. MMB 600 x 1000 Ref. MMB 600 x 1200 Ref. MMB 600 x 1400 Ref. MMB 600 x 1600 Ref. MMB 600 x 1800	Ref. MMB 800 x 800 Ref. MMB 800 x 1000 Ref. MMB 800 x 1200 Ref. MMB 800 x 1400 Ref. MMB 800 x 1600 Ref. MMB 800 x 1800



Avec verre acrylique incolore, fumé gris ou opale de 3mm ou polycarbonate alvéolaire de 6mm, à préciser à la commande
With 3mm colourless, gray tinted or opal acrylic glass or 6mm alveolar polycarbonate, please specify when ordering
Mit 3mm Klar, grau Rauch oder Opal Acrylglas oder 6mm Klarpolycarbonat, bitte bei Bestellung angeben

Ref. MMA 600 x 800 Ref. MMA 600 x 1000 Ref. MMA 600 x 1200 Ref. MMA 600 x 1400 Ref. MMA 600 x 1600 Ref. MMA 600 x 1800	Ref. MMA 800 x 800 Ref. MMA 800 x 1000 Ref. MMA 800 x 1200 Ref. MMA 800 x 1400 Ref. MMA 800 x 1600 Ref. MMA 800 x 1800
---	---

Prix unitaire	Unit price	Stückpreis
<p>Ref. MVT 280 → 10 - 28mm Ref. MVT 380 → 20 - 38mm</p>		<p>Ref. MVT 280 Ref. MVT 380</p>
		<p>Ref. MVU 280 Ref. MVU 380</p>
<p>Position et quantité de pinces nécessaires selon l'implantation Clamps position and number required depending on the layout Klammern Positionen und Mengen erforderlich je nach Standort.</p>	<p>FIXATION POUR BUREAUX BENCH Veuillez préciser l'épaisseur du plateau</p>	<p>FIXING FOR BENCH DESKS Please specify the thickness of the desk surface</p>
	<p>BEFESTIGUNG FÜR BENCH SCHREIBTISCHE Bitte geben Sie die Stärke der Tischplatte an</p>	

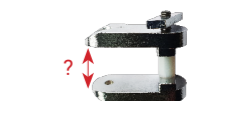
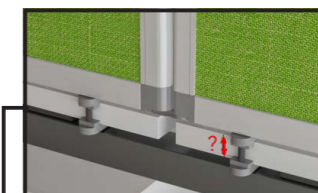

Ref. PBS

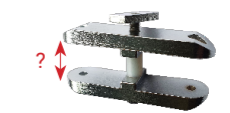
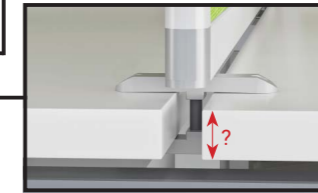

Ref. PBD

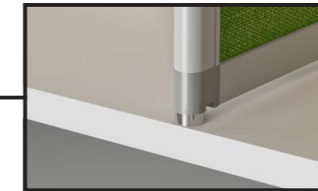

Ref. CYL

Sabot à poser sur le bureau Base to place on the desk Sockel auf den Tisch zu lege

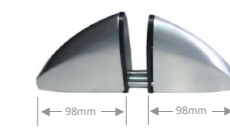

Ref. MVZ 200



TISSU



FABRIC



STOFF

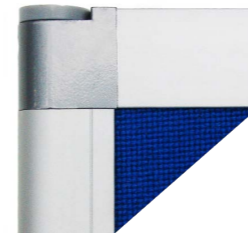

40% laine et 60% viscose

40% wool and 60% viscose

40% Wolle und 60% Viskose

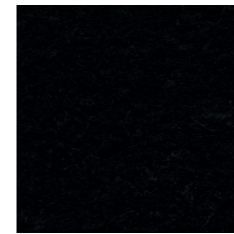

A 204



A 243



A 220

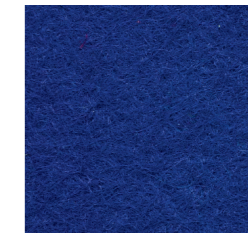

A 228

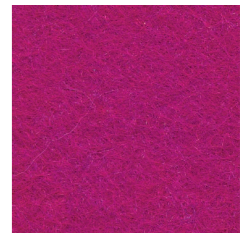

A 221



A 203



A 244



A 232

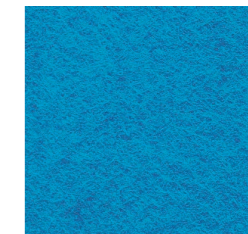

A 229



A 201

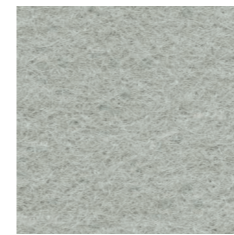

A 230

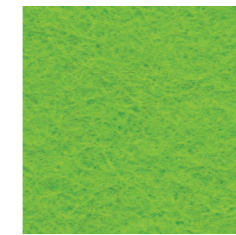

A 235

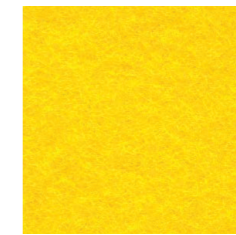

A 206

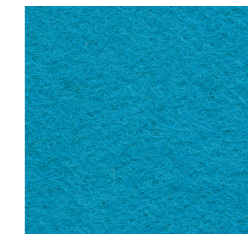

A 231

Moucheté

Speckled

Gesprenkelter

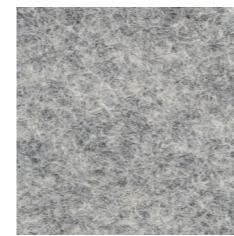

G 365



G 366



G 369

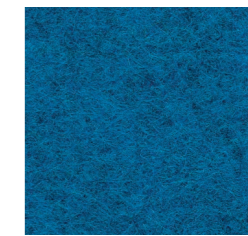

G 370

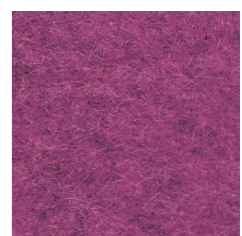

G 368

Pour d'autres gammes ou coloris, veuillez nous consulter.

Les photographies des tissus sont présentées à titre indicatif. Des variations de couleurs peuvent se produire. Nous vous conseillons de demander de vrais échantillons.

For other fabric range or colours, please contact us.

The photographs of the fabric finishes are shown as a guideline only. Colours may vary. We recommend that you ask for samples before ordering.

Andere Stoffe oder Farbe, kontaktieren Sie uns.

Die Abbildungen der Stoffbeschichtungen sind unverbindlich. Es können Farbabweichungen auftreten. Wir empfehlen Ihnen, echte Probenmuster anzufordern.

**TESTS
ACOUSTIQUES**

**ACOUSTIC
TESTS**

AKUSTIKTESTE

TISSU

FABRIC

STOFF



ACOUSTIQUE

ACOUSTIC

AKUSTIK



SUPER-ACOUSTIQUE

SUPER-ACOUSTIC

SUPER-AKUSTIK

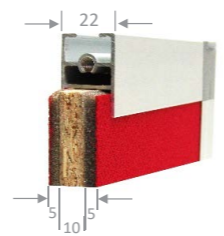
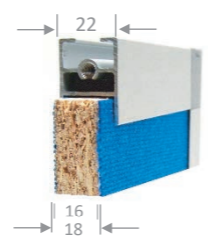

- 2 x 5mm de mousse + tissu
- 2 x 5mm foam + fabric
- 2 x 5mm Schaum + Stoff



Le coefficient α_s exprime l'absorption de l'énergie sonore par la cloison de 0 à 1 (0 à 100%). Dans les bureaux, les fréquences se situent généralement entre 500 et 4000 Hertz (sons graves ou aigus). Le coefficient α_w exprime l'absorption acoustique pondérée.

The α_s coefficient is used to describe the partition's sound absorption on a scale from 0 to 1 (0 to 100%). In offices, these levels generally remain between 500 and 4000 Hertz (low- or high-pitched sounds). The α_w coefficient describes the weighted acoustic absorption.

Der Koeffizient α_s gibt die von der Trennwand absorbierte Schallenergie von 0 bis 1 (0 bis 100%) an. In Büros liegen die Frequenzen in der Regel zwischen 500 und 4000 Hertz (tiefe oder hohe Töne). Der Koeffizient α_w gibt den gewichteten Schallabsorptionsgrad an.

α_w	Mélangé	Tissu	Acoustique	Super-Acoustique
	Melamine	Fabric	Acoustic	Super-Acoustic
	Melamin	Stoff	Akustik	Super-Akustik
	0,05(I)	0,1(I)	0,15(H)	0,45(H)
Frequency (Hz)	α_s			
100	0,00	0,00	0,00	0,13
125	0,00	0,01	0,00	0,19
160	0,02	0,00	0,04	0,22
200	0,00	0,00	0,04	0,26
250	0,03	0,05	0,07	0,30
315	0,02	0,04	0,05	0,28
400	0,02	0,03	0,04	0,32
500	0,01	0,02	0,05	0,36
630	0,03	0,04	0,08	0,41
800	0,02	0,04	0,12	0,45
1000	0,03	0,05	0,14	0,52
1250	0,04	0,08	0,16	0,60
1600	0,03	0,09	0,21	0,70
2000	0,04	0,08	0,24	0,79
2500	0,05	0,10	0,31	0,87
3150	0,04	0,09	0,38	0,91
4000	0,08	0,11	0,44	0,94
5000	0,20	0,21	0,53	0,96

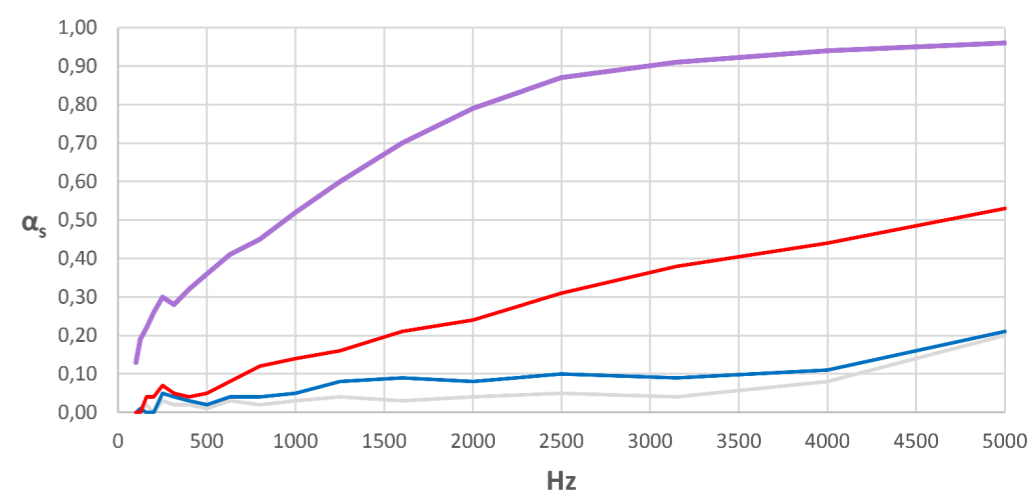
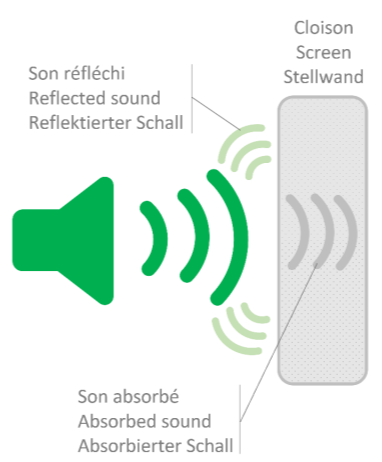

Solutions Acoustiques page 42

Acoustic Solutions page 42

Akustische Lösungen Seite 42

 **CLOISONNETTE
TISSU**

 **FABRIC
SCREEN**

 **STOFF-
STELLWAND**



Kit de montage livré avec chaque cloisonnette

Fitting set supplied with each screen

Ein Bausatz versorgt mit jeder Stellwand

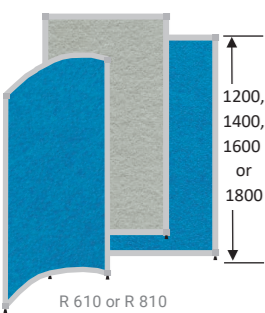

Hauteur Height Höhe	1200 mm	1400 mm	1600 mm	1800 mm
	Ref. MTT 1200 x 610 Ref. MTT 1200 x 810 Ref. MTT 1200 x 1010 Ref. MTT 1200 x 1210 Ref. MTT 1200 x 1410 Ref. MTT 1200 x 1610	Ref. MTT 1400 x 610 Ref. MTT 1400 x 810 Ref. MTT 1400 x 1010 Ref. MTT 1400 x 1210 Ref. MTT 1400 x 1410 Ref. MTT 1400 x 1610	Ref. MTT 1600 x 610 Ref. MTT 1600 x 810 Ref. MTT 1600 x 1010 Ref. MTT 1600 x 1210 Ref. MTT 1600 x 1410 Ref. MTT 1600 x 1610	Ref. MTT 1800 x 610 Ref. MTT 1800 x 810 Ref. MTT 1800 x 1010 Ref. MTT 1800 x 1210 Ref. MTT 1800 x 1410 Ref. MTT 1800 x 1610
	Ref. MTT 1200 x R610 Ref. MTT 1200 x R810	Ref. MTT 1400 x R610 Ref. MTT 1400 x R810	Ref. MTT 1600 x R610 Ref. MTT 1600 x R810	Ref. MTT 1800 x R610 Ref. MTT 1800 x R810

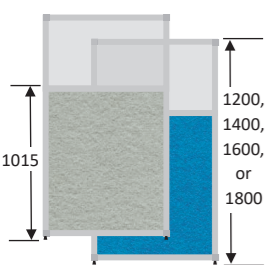

Avec verre acrylique 3mm ou polycarbonate alvéolaire 6mm
With 3mm acrylic glass or 6mm alveolar polycarbonate
Mit 3mm Acrylglas oder 6mm Klarpolycarbonat



Ref. _____	1200 x 610	1400 x 610	1600 x 610	1800 x 610
Ref. _____	1200 x 810	1400 x 810	1600 x 810	1800 x 810
Ref. _____	1200 x 1010	1400 x 1010	1600 x 1010	1800 x 1010
Ref. _____	1200 x 1210	1400 x 1210	1600 x 1210	1800 x 1210
Ref. _____	1200 x 1410	1400 x 1410	1600 x 1410	1800 x 1410
Ref. _____	1200 x 1610	1400 x 1610	1600 x 1610	1800 x 1610

Ref. MTJ	Incolore
	Colourless
	Klar

Ref. MTG	Fumé gris
	Gray tinted
	Grau Rauch

Ref. MTL	Opale
	Opal
	Opal

Ref. MTP	Polycarbonate alvéolaire incolore
	Classement feu M1 / B, s1, d0
	Clear alveolar polycarbonate
	Fire safety classification B, s1, d0
	Klarpolycarbonat
	Feuersicherung Class B, s1, d0



Ref. MVP 300
Pied sur platine plate
Prix unitaire
Foot on flat plate
Unit price
Fuß auf flacher Platte
Stückpreis

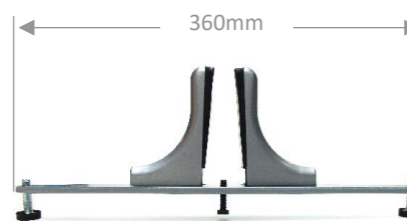

Ref. MVP 360
Pied Réglable
Prix unitaire
Adjustable foot
Unit price
Verstellbarer Fuß
Stückpreis

 **ÉCRAN DE BUREAU
TISSU**

 **FABRIC
DESK SCREEN**

 **STOFF-
TISCH-TRENNWAND**

Hauteur Height Höhe	400 mm	600 mm	800 mm
	Ref. MTB 400 x 800 Ref. MTB 400 x 1000 Ref. MTB 400 x 1200 Ref. MTB 400 x 1400 Ref. MTB 400 x 1600 Ref. MTB 400 x 1800	Ref. MTB 600 x 800 Ref. MTB 600 x 1000 Ref. MTB 600 x 1200 Ref. MTB 600 x 1400 Ref. MTB 600 x 1600 Ref. MTB 600 x 1800	Ref. MTB 800 x 800 Ref. MTB 800 x 1000 Ref. MTB 800 x 1200 Ref. MTB 800 x 1400 Ref. MTB 800 x 1600 Ref. MTB 800 x 1800

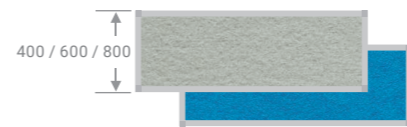

Avec verre acrylique incolore, fumé gris ou opale de 3mm ou polycarbonate alvéolaire de 6mm, à préciser à la commande
With 3mm colourless, gray tinted or opal acrylic glass or 6mm alveolar polycarbonate, please specify when ordering
Mit 3mm Klar, grau Rauch oder Opal Acrylglas oder 6mm Klarpolycarbonat, bitte bei Bestellung angeben

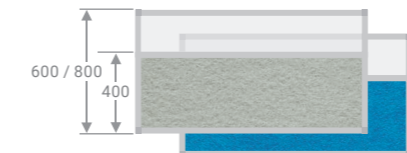

Prix unitaire	Unit price	Stückpreis
	Ref. MTA 600 x 800 Ref. MTA 600 x 1000 Ref. MTA 600 x 1200 Ref. MTA 600 x 1400 Ref. MTA 600 x 1600 Ref. MTA 600 x 1800	Ref. MTA 800 x 800 Ref. MTA 800 x 1000 Ref. MTA 800 x 1200 Ref. MTA 800 x 1400 Ref. MTA 800 x 1600 Ref. MTA 800 x 1800

Ref. MVT 280 → 10 - 28mm
Ref. MVT 380 → 20 - 38mm

Position et quantité de pinces nécessaires selon l'implantation
Clamps position and number required depending on the layout
Klammern Positionen und Mengen erforderlich je nach Standort.

Ref. MVU 280
Ref. MVU 380

FIXATION POUR BUREAUX BENCH
Veillez préciser l'épaisseur du plateau

FIXING FOR BENCH DESKS
Please specify the thickness of the desk surface

BEFESTIGUNG FÜR BENCH SCHREIBTISCHE
Bitte geben Sie die Stärke der Tischplatte an

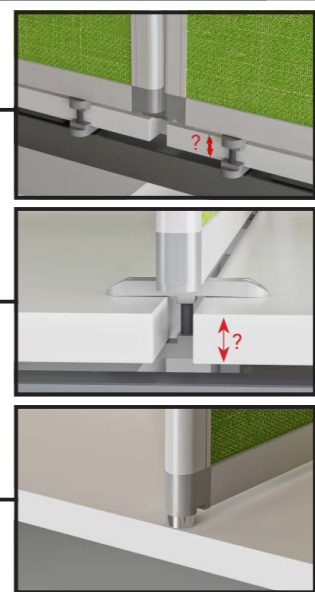

Ref. PBS
Ref. PBD
Ref. CYL

Sabot à poser sur le bureau Base to place on the desk Sockel auf den Tisch zu lege



**CLOISONNETTE
ACOUSTIQUE**

**ACOUSTIC
SCREEN**

**AKUSTIK-
STELLWAND**



Kit de montage livré avec chaque cloisonnette

Fitting set supplied with each screen

Ein Bausatz versorgt mit jeder Stellwand

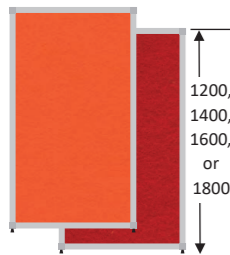

Hauteur Height Höhe	1200 mm	1400 mm	1600 mm	1800 mm
1200, 1400, 1600, or 1800	Ref. FTT 1200 x 610 Ref. FTT 1200 x 810 Ref. FTT 1200 x 1010 Ref. FTT 1200 x 1210 Ref. FTT 1200 x 1410 Ref. FTT 1200 x 1610	Ref. FTT 1400 x 610 Ref. FTT 1400 x 810 Ref. FTT 1400 x 1010 Ref. FTT 1400 x 1210 Ref. FTT 1400 x 1410 Ref. FTT 1400 x 1610	Ref. FTT 1600 x 610 Ref. FTT 1600 x 810 Ref. FTT 1600 x 1010 Ref. FTT 1600 x 1210 Ref. FTT 1600 x 1410 Ref. FTT 1600 x 1610	Ref. FTT 1800 x 610 Ref. FTT 1800 x 810 Ref. FTT 1800 x 1010 Ref. FTT 1800 x 1210 Ref. FTT 1800 x 1410 Ref. FTT 1800 x 1610

Avec verre acrylique 3mm ou polycarbonate alvéolaire 6mm
With 3mm acrylic glass or 6mm alveolar polycarbonate
Mit 3mm Acrylglas oder 6mm Klarpolycarbonat

Ref. ____ 1200 x 610 Ref. ____ 1200 x 810 Ref. ____ 1200 x 1010 Ref. ____ 1200 x 1210 Ref. ____ 1200 x 1410 Ref. ____ 1200 x 1610	Ref. ____ 1400 x 610 Ref. ____ 1400 x 810 Ref. ____ 1400 x 1010 Ref. ____ 1400 x 1210 Ref. ____ 1400 x 1410 Ref. ____ 1400 x 1610	Ref. ____ 1600 x 610 Ref. ____ 1600 x 810 Ref. ____ 1600 x 1010 Ref. ____ 1600 x 1210 Ref. ____ 1600 x 1410 Ref. ____ 1600 x 1610	Ref. ____ 1800 x 610 Ref. ____ 1800 x 810 Ref. ____ 1800 x 1010 Ref. ____ 1800 x 1210 Ref. ____ 1800 x 1410 Ref. ____ 1800 x 1610
--	--	--	--



Ref. FTJ

Incolore
Colourless
Klar



Ref. FTG

Fumé gris
Gray tinted
Grau Rauch

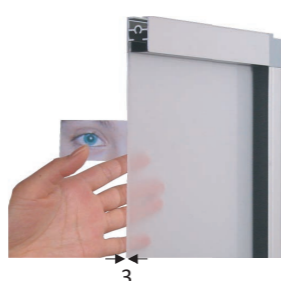

Ref. FTL

Opale
Opal
Opal



Ref. FTP

Polycarbonate alvéolaire incolore
Classement feu M1 / B, s1, d0
Clear alveolar polycarbonate
Fire safety classification B, s1, d0
Klarpolycarbonat
Feuersicherung Class B, s1, d0



Ref. MVP 300

Pied sur platine plate
Prix unitaire
Foot on flat plate
Unit price
Fuß auf flacher Platte
Stückpreis

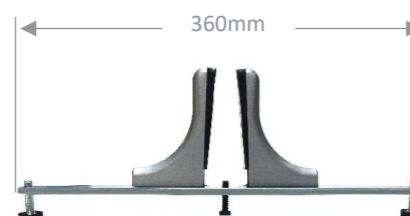

Ref. MVP 360

Pied Réglable
Prix unitaire
Adjustable foot
Unit price
Verstellbarer Fuß
Stückpreis

**ÉCRAN DE BUREAU
ACOUSTIQUE**

**ACOUSTIC
DESK SCREEN**

**AKUSTIK-
TISCH-TRENNWAND**

Hauteur Height Höhe	400 mm	600 mm	800 mm
400 / 600 / 800	Ref. FPB 400 x 800 Ref. FPB 400 x 1000 Ref. FPB 400 x 1200 Ref. FPB 400 x 1400 Ref. FPB 400 x 1600 Ref. FPB 400 x 1800	Ref. FPB 600 x 800 Ref. FPB 600 x 1000 Ref. FPB 600 x 1200 Ref. FPB 600 x 1400 Ref. FPB 600 x 1600 Ref. FPB 600 x 1800	Ref. FPB 800 x 800 Ref. FPB 800 x 1000 Ref. FPB 800 x 1200 Ref. FPB 800 x 1400 Ref. FPB 800 x 1600 Ref. FPB 800 x 1800



Avec verre acrylique incolore, fumé gris ou opale de 3mm ou polycarbonate alvéolaire de 6mm, à préciser à la commande
With 3mm colourless, gray tinted or opal acrylic glass or 6mm alveolar polycarbonate, please specify when ordering
Mit 3mm Klar, grau Rauch oder Opal Acrylglas oder 6mm Klarpolycarbonat, bitte bei Bestellung angeben



Ref. FPA 600 x 800 Ref. FPA 600 x 1000 Ref. FPA 600 x 1200 Ref. FPA 600 x 1400 Ref. FPA 600 x 1600 Ref. FPA 600 x 1800	Ref. FPA 800 x 800 Ref. FPA 800 x 1000 Ref. FPA 800 x 1200 Ref. FPA 800 x 1400 Ref. FPA 800 x 1600 Ref. FPA 800 x 1800
---	---

Prix unitaire	Unit price	Stückpreis
---------------	------------	------------



Ref. MVT 280
Ref. MVT 380

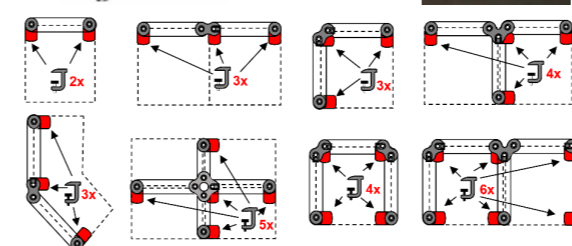

Ref. MVU 280
Ref. MVU 380

Position et quantité de pinces nécessaires selon l'implantation
Clamps position and number required depending on the layout
Klammern Positionen und Mengen erforderlich je nach Standort.

FIXATION POUR BUREAUX BENCH
Veuillez préciser l'épaisseur du plateau
FIXING FOR BENCH DESKS
Please specify the thickness of the desk surface
BEFESTIGUNG FÜR BENCH SCHREIBTISCHE
Bitte geben Sie die Stärke der Tischplatte an



Sabot à poser sur le bureau

Base to place on the desk

Sockel auf den Tisch zu lege

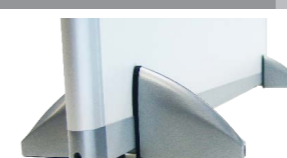

Ref. MVZ 200



**CLOISONNETTE
SUPER-ACOUSTIQUE**

**SUPER-ACOUSTIC
SCREEN**

**SUPER AKUSTIK-
STELLWAND**



Kit de montage livré avec chaque cloisonnette

Fitting set supplied with each screen

Ein Bausatz versorgt mit jeder Stellwand

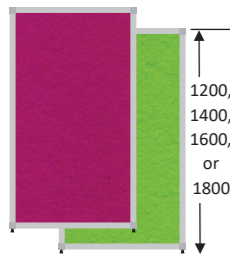

Hauteur Height Höhe	1200 mm	1400 mm	1600 mm	1800 mm
	Ref. ATT 1200 x 610 Ref. ATT 1200 x 810 Ref. ATT 1200 x 1010 Ref. ATT 1200 x 1210 Ref. ATT 1200 x 1410 Ref. ATT 1200 x 1610	Ref. ATT 1400 x 610 Ref. ATT 1400 x 810 Ref. ATT 1400 x 1010 Ref. ATT 1400 x 1210 Ref. ATT 1400 x 1410 Ref. ATT 1400 x 1610	Ref. ATT 1600 x 610 Ref. ATT 1600 x 810 Ref. ATT 1600 x 1010 Ref. ATT 1600 x 1210 Ref. ATT 1600 x 1410 Ref. ATT 1600 x 1610	Ref. ATT 1800 x 610 Ref. ATT 1800 x 810 Ref. ATT 1800 x 1010 Ref. ATT 1800 x 1210 Ref. ATT 1800 x 1410 Ref. ATT 1800 x 1610

Avec verre acrylique 3mm ou polycarbonate alvéolaire 6mm
With 3mm acrylic glass or 6mm alveolar polycarbonate
Mit 3mm Acrylglas oder 6mm Klarpolycarbonat

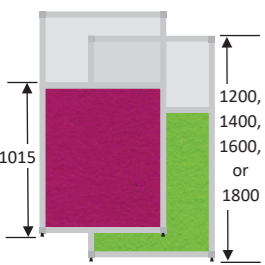

Ref. ATJ	Ref. ATG	Ref. ATL	Ref. ATP
Incolore	Fumé gris	Opale	Polycarbonate alvéolaire incolore Classement feu M1 / B, s1, d0
Colourless	Gray tinted	Opal	Clear alveolar polycarbonate Fire safety classification B, s1, d0
Klar	Grau Rauch	Opal	Klarpolycarbonat Feuersicherung Class B, s1, d0

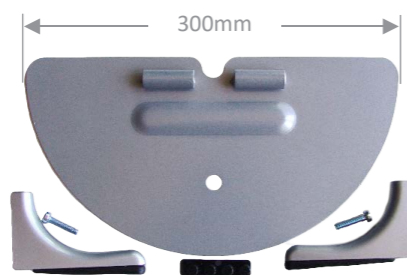

Ref. MVP 300
Pied sur platine plate
Prix unitaire
Foot on flat plate
Unit price
Fuß auf flacher Platte
Stückpreis

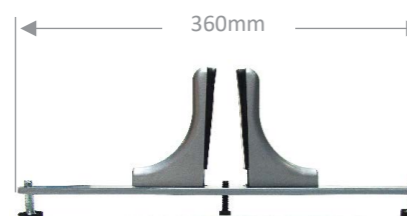

Ref. MVP 360
Pied Réglable
Prix unitaire
Adjustable foot
Unit price
Verstellbarer Fuß
Stückpreis

**ÉCRAN DE BUREAU
SUPER-ACOUSTIQUE**

**SUPER-ACOUSTIC
DESK SCREEN**

**SUPER AKUSTIK-
TISCH-TRENNWAND**

Hauteur Height Höhe	400 mm	600 mm	800 mm
	Ref. ATB 400 x 800 Ref. ATB 400 x 1000 Ref. ATB 400 x 1200 Ref. ATB 400 x 1400 Ref. ATB 400 x 1600 Ref. ATB 400 x 1800	Ref. ATB 600 x 800 Ref. ATB 600 x 1000 Ref. ATB 600 x 1200 Ref. ATB 600 x 1400 Ref. ATB 600 x 1600 Ref. ATB 600 x 1800	Ref. ATB 800 x 800 Ref. ATB 800 x 1000 Ref. ATB 800 x 1200 Ref. ATB 800 x 1400 Ref. ATB 800 x 1600 Ref. ATB 800 x 1800



Avec verre acrylique incolore, fumé gris ou opale de 3mm ou polycarbonate alvéolaire de 6mm, à préciser à la commande

With 3mm colourless, gray tinted or opal acrylic glass or 6mm alveolar polycarbonate, please specify when ordering

Mit 3mm Klar, grau Rauch oder Opal Acrylglas oder 6mm Klarpolycarbonat, bitte bei Bestellung angeben



Ref. ATA 600 x 800 Ref. ATA 600 x 1000 Ref. ATA 600 x 1200 Ref. ATA 600 x 1400 Ref. ATA 600 x 1600 Ref. ATA 600 x 1800	Ref. ATA 800 x 800 Ref. ATA 800 x 1000 Ref. ATA 800 x 1200 Ref. ATA 800 x 1400 Ref. ATA 800 x 1600 Ref. ATA 800 x 1800
---	---

Prix unitaire	Unit price	Stückpreis
<p>Ref. MVT 280 → 10 - 28mm Ref. MVT 380 → 20 - 38mm</p>		<p>Ref. MVT 280 Ref. MVT 380</p>
<p>Position et quantité de pinces nécessaires selon l'implantation Clamps position and number required depending on the layout Klammern Positionen und Mengen erforderlich je nach Standort.</p>		<p>Ref. MVU 280 Ref. MVU 380</p>
<p>FIXATION POUR BUREAUX BENCH Veillez préciser l'épaisseur du plateau</p>	<p>FIXING FOR BENCH DESKS Please specify the thickness of the desk surface</p>	<p>BEFESTIGUNG FÜR BENCH SCHREIBTISCHE Bitte geben Sie die Stärke der Tischplatte an</p>

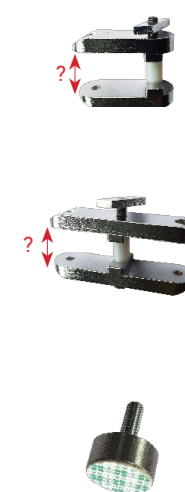
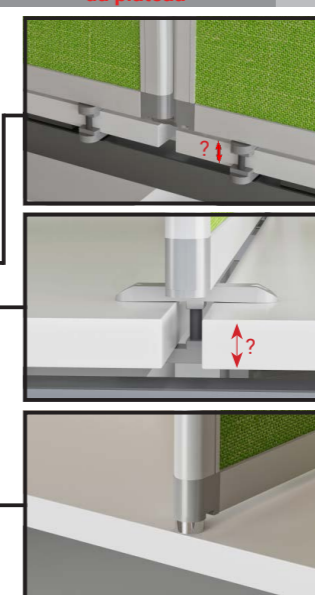

Sabot à poser sur le bureau

Base to place on the desk

Sockel auf den Tisch zu lege

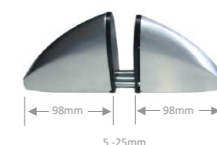

Ref. MVZ 200

 **VERRE ACRYLIQUE
+ POLYCARBONATE**

 **ACRYLIC GLASS +
POLYCARBONATE**

 **ACRYLGLAS +
POLYCARBONAT**

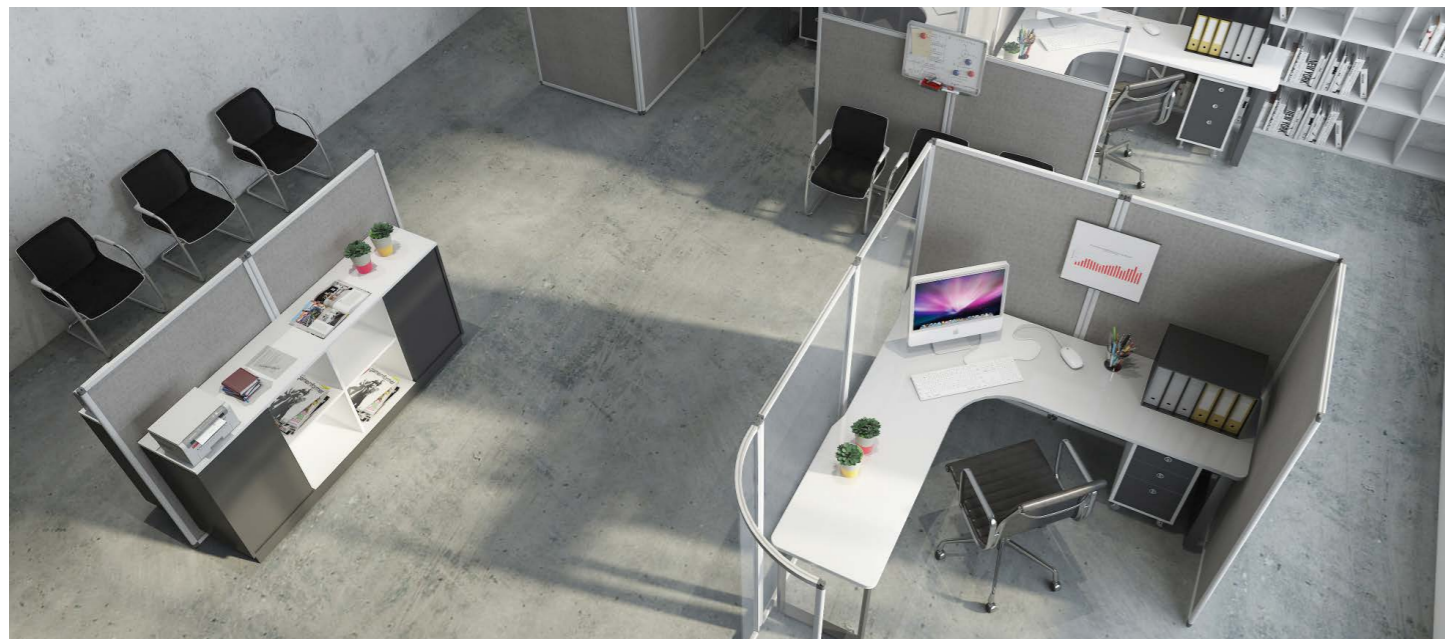

Store
pour cloisonnettes en verre acrylique

Venetian blind
for acrylic glass screens

Jalousie
für Acrylglas Stellwände

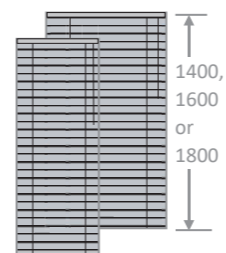

Hauteur
Height
Höhe **1400 mm**

1600 mm

1800 mm

Ref. MVV 1400 x 610
Ref. MVV 1400 x 810
Ref. MVV 1400 x 1010
Ref. MVV 1400 x 1210

Ref. MVV 1600 x 610
Ref. MVV 1600 x 810
Ref. MVV 1600 x 1010
Ref. MVV 1600 x 1210

Ref. MVV 1800 x 610
Ref. MVV 1800 x 810
Ref. MVV 1800 x 1010
Ref. MVV 1800 x 1210

**CLOISONNETTE
VERRE ACRYLIQUE
+ POLYCARBONATE**

**ACRYLIC GLASS +
POLYCARBONATE
SCREEN**

**ACRYLGLAS +
POLYCARBONAT
STELLWAND**

**ÉCRAN DE BUREAU
VERRE ACRYLIQUE
+ POLYCARBONATE**

**ACRYLIC GLASS +
POLYCARBONATE
DESK SCREEN**

**ACRYLGLAS +
POLYCARBONAT
TISCH-TRENNWAND**

Kit de montage livré avec chaque cloisonnette
Fitting set supplied with each screen
Ein Bausatz versorgt mit jeder Stellwand

Hauteur Height Höhe	1200 mm	1400 mm	1600 mm	1800 mm
	Ref. _____ 1200 x 610 Ref. _____ 1200 x 810 Ref. _____ 1200 x 1010 Ref. _____ 1200 x 1210	Ref. _____ 1400 x 610 Ref. _____ 1400 x 810 Ref. _____ 1400 x 1010 Ref. _____ 1400 x 1210	Ref. _____ 1600 x 610 Ref. _____ 1600 x 810 Ref. _____ 1600 x 1010 Ref. _____ 1600 x 1210	Ref. _____ 1800 x 610 Ref. _____ 1800 x 810 Ref. _____ 1800 x 1010 Ref. _____ 1800 x 1210
	Ref. _____ 1200 x R610 Ref. _____ 1200 x R810	Ref. _____ 1400 x R610 Ref. _____ 1400 x R810	Ref. _____ 1600 x R610 Ref. _____ 1600 x R810	Ref. _____ 1800 x R610 Ref. _____ 1800 x R810

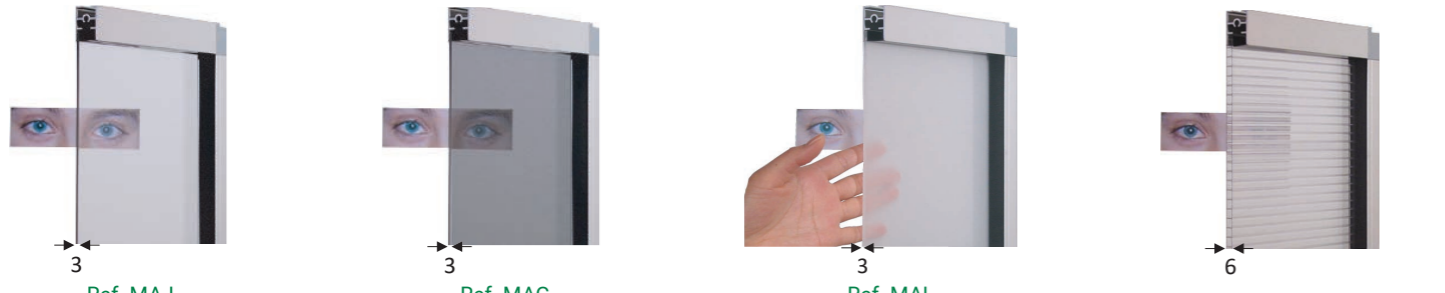

Ref. MAJ	Ref. MAG	Ref. MAL	Polycarbonate alvéolaire incolore Classement feu M1 / B, s1, d0
Incolore	Fumé gris	Opale	Clear alveolar polycarbonate Fire safety classification B, s1, d0
Colourless	Gray tinted	Opal	Klarpolycarbonat Feuersicherung Class B, s1, d0
Klar	Grau Rauch	Opal	

Avec polycarbonate alvéolaire 6mm
With 6mm alveolar polycarbonate
Mit 6mm Klarpolycarbonat

Ref. MAP 1200 x 610 Ref. MAP 1200 x 810 Ref. MAP 1200 x 1010 Ref. MAP 1200 x 1210 Ref. MAP 1200 x 1410 Ref. MAP 1200 x 1610 Ref. MAP 1200 x R810	Ref. MAP 1400 x 610 Ref. MAP 1400 x 810 Ref. MAP 1400 x 1010 Ref. MAP 1400 x 1210 Ref. MAP 1400 x 1410 Ref. MAP 1400 x 1610 Ref. MAP 1400 x R810	Ref. MAP 1600 x 610 Ref. MAP 1600 x 810 Ref. MAP 1600 x 1010 Ref. MAP 1600 x 1210 Ref. MAP 1600 x 1410 Ref. MAP 1600 x 1610 Ref. MAP 1600 x R810	Ref. MAP 1800 x 610 Ref. MAP 1800 x 810 Ref. MAP 1800 x 1010 Ref. MAP 1800 x 1210 Ref. MAP 1800 x 1410 Ref. MAP 1800 x 1610
--	--	--	--



Ref. MVP 300
Pied sur platine plate
Prix unitaire
Foot on flat plate
Unit price
Fuß auf flacher Platte
Stückpreis



Ref. MVP 360
Pied Réglable
Prix unitaire
Adjustable foot
Unit price
Verstellbarer Fuß
Stückpreis

Avec verre acrylique incolore, fumé gris ou opale de 3mm ou polycarbonate alvéolaire de 6mm, à préciser à la commande
With 3mm colourless, gray tinted or opal acrylic glass or 6mm alveolar polycarbonate, please specify when ordering
Mit 3mm Klar, grau Rauch oder Opal Acrylglas oder 6mm Klarpolycarbonat, bitte bei Bestellung angeben

Hauteur Height Höhe	400 mm	600 mm	800 mm
	Ref. MVA 400 x 800 Ref. MVA 400 x 1000 Ref. MVA 400 x 1200 Ref. MVA 400 x 1400 Ref. MVA 400 x 1600 Ref. MVA 400 x 1800	Ref. MVA 600 x 800 Ref. MVA 600 x 1000 Ref. MVA 600 x 1200 Ref. MVA 600 x 1400 Ref. MVA 600 x 1600 Ref. MVA 600 x 1800	Ref. MVA 800 x 800 Ref. MVA 800 x 1000 Ref. MVA 800 x 1200 Ref. MVA 800 x 1400 Ref. MVA 800 x 1600 Ref. MVA 800 x 1800

Prix unitaire	Unit price	Stückpreis	
<p>Ref. MVT 280 → 10 – 28mm Ref. MVT 380 → 20 – 38mm</p>		<p>Ref. MVT 280 Ref. MVT 380</p>	
<p>Position et quantité de pinces nécessaires selon l'implantation Clamps position and number required depending on the layout Klammern Positionen und Mengen erforderlich je nach Standort.</p>		<p>Ref. MVU 280 Ref. MVU 380</p>	
	<p>FIXATION POUR BUREAUX BENCH Veuillez préciser l'épaisseur du plateau</p>	<p>FIXING FOR BENCH DESKS Please specify the thickness of the desk surface</p>	<p>BEFESTIGUNG FÜR BENCH SCHREIBTISCHE Bitte geben Sie die Stärke der Tischplatte an</p>

		<p>Ref. PBS</p>
		<p>Ref. PBD</p>
		<p>Ref. CYL</p>

Sabot à poser sur le bureau	Base to place on the desk	Sockel auf den Tisch zu lege
		<p>Ref. MVZ 200</p>

PANNEAUX D’AFFICHAGE MAGNÉTIQUES

MAGNETIC NOTICE BOARDS

MAGNETISCHE ANSCHLAGTAFELN



Kit de montage livré avec chaque cloisonnette

Fitting set supplied with each screen

Ein Bausatz versorgt mit jeder Stellwand

ÉCRAN DE BUREAU MAGNÉTIQUE

MAGNETIC DESK SCREEN

MAGNETISCH TISCH-TRENNWAND

Hauteur			
Height	400 mm	600 mm	800 mm
Höhe			

Ref. TPB 400 x 800
Ref. TPB 400 x 1000
Ref. TPB 400 x 1200
Ref. TPB 400 x 1400
Ref. TPB 400 x 1600
Ref. TPB 400 x 1800

Ref. TPB 600 x 800
Ref. TPB 600 x 1000
Ref. TPB 600 x 1200
Ref. TPB 600 x 1400
Ref. TPB 600 x 1600
Ref. TPB 600 x 1800

Ref. TPB 800 x 800
Ref. TPB 800 x 1000
Ref. TPB 800 x 1200
Ref. TPB 800 x 1400
Ref. TPB 800 x 1600
Ref. TPB 800 x 1800



Avec verre acrylique incolore, fumé gris ou opale de 3mm ou polycarbonate alvéolaire de 6mm, à préciser à la commande

With 3mm colourless, gray tinted or opal acrylic glass or 6mm alveolar polycarbonate, please specify when ordering

Mit 3mm Klar, grau Rauch oder Opal Acrylglas oder 6mm Klarpolycarbonat, bitte bei Bestellung angeben



Ref. TPA 600 x 800
Ref. TPA 600 x 1000
Ref. TPA 600 x 1200
Ref. TPA 600 x 1400
Ref. TPA 600 x 1600
Ref. TPA 600 x 1800

Ref. TPA 800 x 800
Ref. TPA 800 x 1000
Ref. TPA 800 x 1200
Ref. TPA 800 x 1400
Ref. TPA 800 x 1600
Ref. TPA 800 x 1800

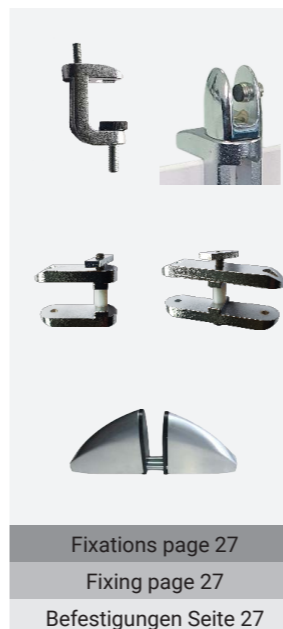

Fixations page 27
Fixing page 27
Befestigungen Seite 27

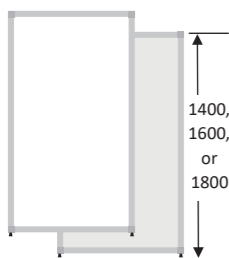

Hauteur			
Height	1400 mm	1600 mm	1800 mm
Höhe			
1 face magnétique émaillée + 1 face mélaminé blanc			
1 enamelled magnetic side + 1 side white melamine			
1 emailiert magnetisch Seite + 1 weiße melaminierte Seite			

Ref. TMM 1400 x 610
Ref. TMM 1400 x 810
Ref. TMM 1400 x 1010
Ref. TMM 1400 x 1210

Ref. TMM 1600 x 610
Ref. TMM 1600 x 810
Ref. TMM 1600 x 1010
Ref. TMM 1600 x 1210

Ref. TMM 1800 x 610
Ref. TMM 1800 x 810
Ref. TMM 1800 x 1010
Ref. TMM 1800 x 1210

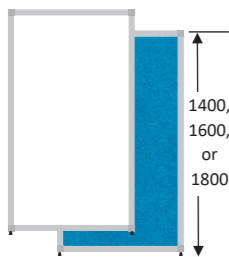

1 face magnétique émaillée + 1 face tissu			
1 enamelled magnetic side + 1 side fabric			
1 emailiert magnetisch Seite + 1 Seite Stoff			

Ref. TTT 1400 x 610
Ref. TTT 1400 x 810
Ref. TTT 1400 x 1010
Ref. TTT 1400 x 1210

Ref. TTT 1600 x 610
Ref. TTT 1600 x 810
Ref. TTT 1600 x 1010
Ref. TTT 1600 x 1210

Ref. TTT 1800 x 610
Ref. TTT 1800 x 810
Ref. TTT 1800 x 1010
Ref. TTT 1800 x 1210

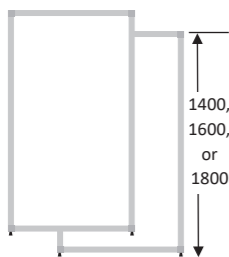

2 faces magnétiques émaillées			
2 enamelled magnetic sides			
2 emailiert magnetisch Seiten			

Ref. TEX 1400 x 610
Ref. TEX 1400 x 810
Ref. TEX 1400 x 1010
Ref. TEX 1400 x 1210

Ref. TEX 1600 x 610
Ref. TEX 1600 x 810
Ref. TEX 1600 x 1010
Ref. TEX 1600 x 1210

Ref. TEX 1800 x 610
Ref. TEX 1800 x 810
Ref. TEX 1800 x 1010
Ref. TEX 1800 x 1210

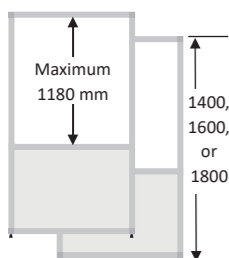

2 faces magnétiques émaillées + Mélaminé			
2 enamelled magnetic sides + Melamine			
2 emailiert magnetisch Seiten + Melamin			

Ref. TMX 1400 x 610
Ref. TMX 1400 x 810
Ref. TMX 1400 x 1010
Ref. TMX 1400 x 1210
Ref. TMX 1400 x 1410
Ref. TMX 1400 x 1610

Ref. TMX 1600 x 610
Ref. TMX 1600 x 810
Ref. TMX 1600 x 1010
Ref. TMX 1600 x 1210
Ref. TMX 1600 x 1410
Ref. TMX 1600 x 1610

Ref. TMX 1800 x 610
Ref. TMX 1800 x 810
Ref. TMX 1800 x 1010
Ref. TMX 1800 x 1210
Ref. TMX 1800 x 1410
Ref. TMX 1800 x 1610

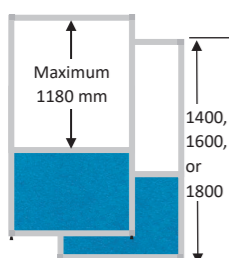

2 faces magnétiques émaillées + Tissu			
2 enamelled magnetic sides + Fabric			
2 emailiert magnetisch Seiten + Stoff			

Ref. TTX 1400 x 610
Ref. TTX 1400 x 810
Ref. TTX 1400 x 1010
Ref. TTX 1400 x 1210
Ref. TTX 1400 x 1410
Ref. TTX 1400 x 1610

Ref. TTX 1600 x 610
Ref. TTX 1600 x 810
Ref. TTX 1600 x 1010
Ref. TTX 1600 x 1210
Ref. TTX 1600 x 1410
Ref. TTX 1600 x 1610

Ref. TTX 1800 x 610
Ref. TTX 1800 x 810
Ref. TTX 1800 x 1010
Ref. TTX 1800 x 1210
Ref. TTX 1800 x 1410
Ref. TTX 1800 x 1610

PIETEMENTS + ROULETTES

FEET + CASTORS

FÜßE + ROLLEN

Nombre de pieds suivant l'implantation :

Number of feet required depends on the layout:

Zahl der Füße kommt darauf das Layout an:

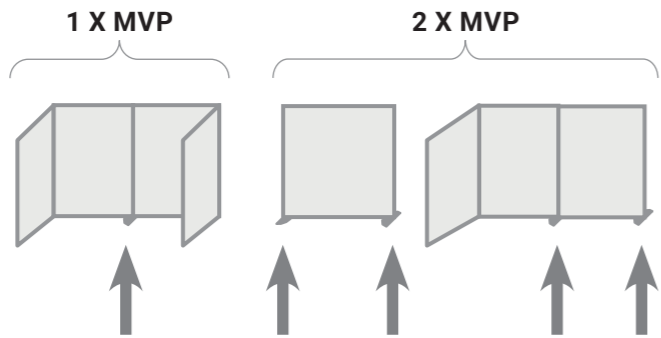

Pas de pied nécessaire pour ces implantations :

No feet required for these layouts:

Für diese Layouts sind keine Füße erforderlich:

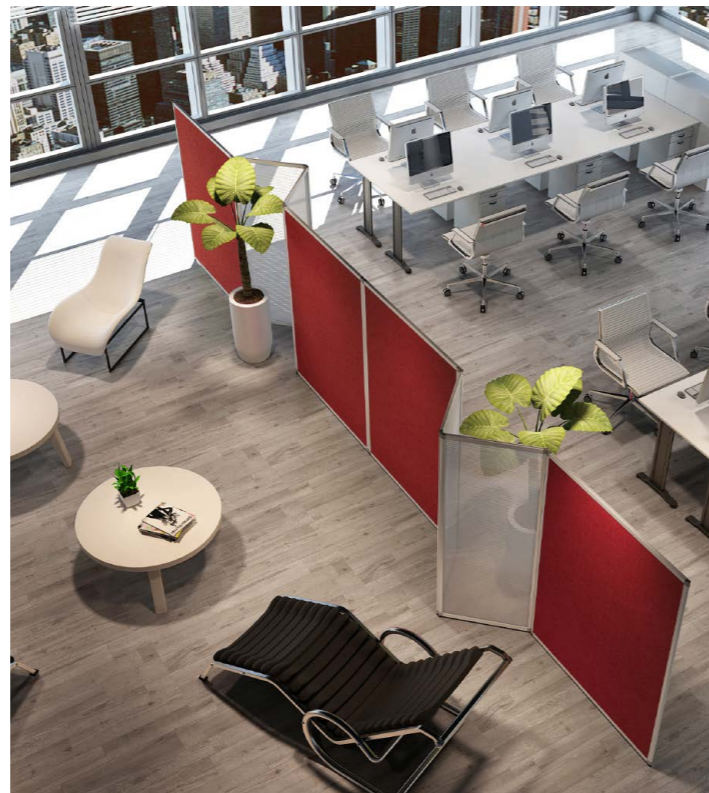
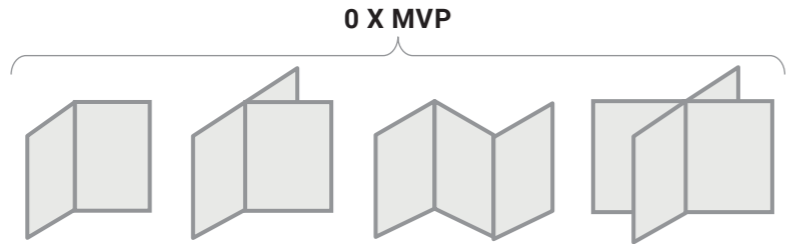

Pied sur platine plate
Prix unitaire

Foot on flat plate
Unit price

Fuß auf flacher Platte
Stückpreis

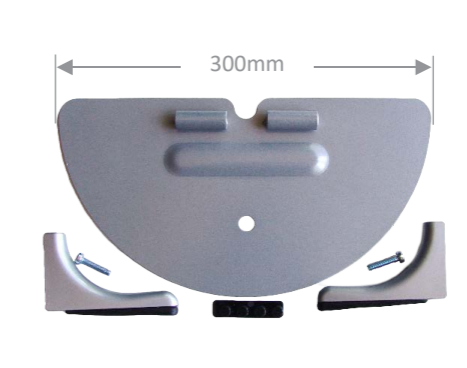

Ref. MVP 300

Pied réglable
Prix unitaire

Adjustable foot
Unit price

Verstellbarer Fuß
Stückpreis



Ref. MVP 360

Kit complet 4 roulettes avec freins
+ 2 barres
(pour hauteur maxi 1800mm)

4 locking castor full set + 2 bars
(for maximum height 1800mm)

Komplettsatz mit 4 Rollen mit Bremsfunktion
(für maxi Höhe 1800mm)

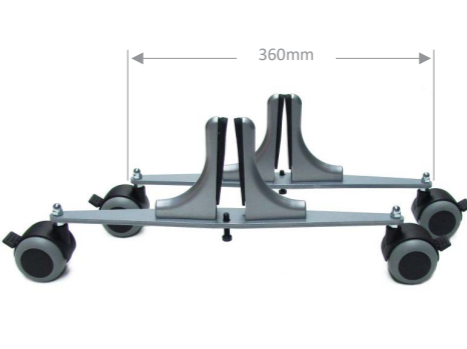

Ref. MVX 380

 **TOLE PERFORÉE
MAGNÉTIQUE**

 **MAGNETIC
PERFORATED
METAL SHEET**

 **MAGNETISCH
LOCHBLECH**

 **PANNEAUX POUR
BANQUE D'ACCUEIL**

 **PANELS FOR
RECEPTION DESK**

 **WÄNDE FÜR
EMPFANGSTHEKE**



Kit de montage livré avec chaque cloisonnette

Fitting set supplied with each screen

Ein Bausatz versorgt mit jeder Stellwand

Hauteur Height Höhe	1200 mm	1400 mm	1600 mm	1800 mm
	Tôle perforée magnétique acier laqué RAL 9006			
	RAL 9006 lacquered magnetic perforated metal sheet			
	Lackierten magnetisch Lochblech RAL 9006			
	Ref. MPP 1200 x 610 Ref. MPP 1200 x 810 Ref. MPP 1200 x 1010	Ref. MPP 1400 x 610 Ref. MPP 1400 x 810 Ref. MPP 1400 x 1010	Ref. MPP 1600 x 610 Ref. MPP 1600 x 810 Ref. MPP 1600 x 1010	Ref. MPP 1800 x 610 Ref. MPP 1800 x 810 Ref. MPP 1800 x 1010

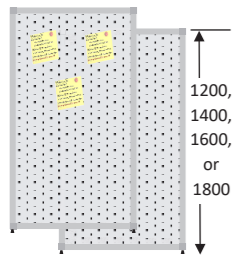

Tôle perforée magnétique acier laqué RAL 9006 + Mélaminé				
RAL 9006 lacquered magnetic perforated metal sheet + Melamine				
Lackierten magnetisch Lochblech RAL 9006 + Melamin				
	Ref. MPM 1400 x 610 Ref. MPM 1400 x 810 Ref. MPM 1400 x 1010 Ref. MPM 1400 x 1210 Ref. MPM 1400 x 1410 Ref. MPM 1400 x 1610	Ref. MPM 1600 x 610 Ref. MPM 1600 x 810 Ref. MPM 1600 x 1010 Ref. MPM 1600 x 1210 Ref. MPM 1600 x 1410 Ref. MPM 1600 x 1610	Ref. MPM 1800 x 610 Ref. MPM 1800 x 810 Ref. MPM 1800 x 1010 Ref. MPM 1800 x 1210 Ref. MPM 1800 x 1410 Ref. MPM 1800 x 1610	

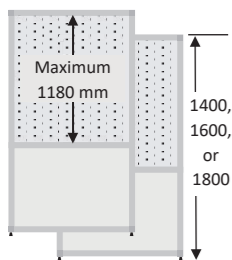

Tôle perforée magnétique acier laqué RAL 9006 + Tissu				
RAL 9006 lacquered magnetic perforated metal sheet + Fabric				
Lackierten magnetisch Lochblech RAL 9006 + Stoff				
	Ref. MPT 1400 x 610 Ref. MPT 1400 x 810 Ref. MPT 1400 x 1010 Ref. MPT 1400 x 1210 Ref. MPT 1400 x 1410 Ref. MPT 1400 x 1610	Ref. MPT 1600 x 610 Ref. MPT 1600 x 810 Ref. MPT 1600 x 1010 Ref. MPT 1600 x 1210 Ref. MPT 1600 x 1410 Ref. MPT 1600 x 1610	Ref. MPT 1800 x 610 Ref. MPT 1800 x 810 Ref. MPT 1800 x 1010 Ref. MPT 1800 x 1210 Ref. MPT 1800 x 1410 Ref. MPT 1800 x 1610	

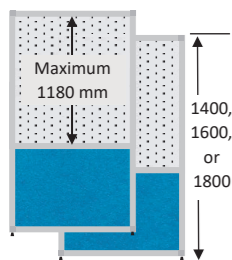

Mélaminé 19mm
19mm melamine
19mm Melamin

Hauteur Height Höhe	1030 mm
	Ref. MMM 1030 x 800 Ref. MMM 1030 x 825 Ref. MMM 1030 x 1000 Ref. MMM 1030 x 1200 Ref. MMM 1030 x 1400 Ref. MMM 1030 x 1600

Tissu
Fabric
Stoff

Ref. MTT 1030 x 800 Ref. MTT 1030 x 825 Ref. MTT 1030 x 1000 Ref. MTT 1030 x 1200 Ref. MTT 1030 x 1400 Ref. MTT 1030 x 1600
Ref. MTT 1030 x R800

Tôle perforée acier laqué RAL 9006
RAL 9006 lacquered perforated metal sheet
Lackierten Lochblech RAL 9006

Ref. MPP 1030 x 800 Ref. MPP 1030 x 825 Ref. MPP 1030 x 1000 Ref. MPP 1030 x 1200 Ref. MPP 1030 x 1400 Ref. MPP 1030 x 1600
Ref. MPP 1030 x R800

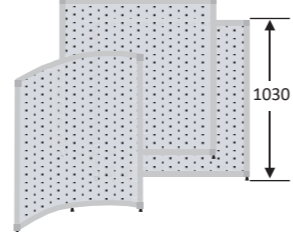

Tablette en verre Securit dépoli 8mm avec supports MCT 230
8mm frosted Securit glass slab with holders MCT 230
Glasplatte, 8mm Securit Mattglas mit Stützer MCT 230

Ref. MCW 300 x 800 Ref. MCW 300 x 1000 Ref. MCW 300 x 1200 Ref. MCW 300 x 1400 Ref. MCW 300 x 1600
Ref. MCW 300 x R800

Support pour tablette bois ou verre
Holder for glass or wooden slab
Stütze für Holz oder Glasplatte





POSTES DE TRAVAIL



WORKSTATIONS



ARBEITSPLÄTZE

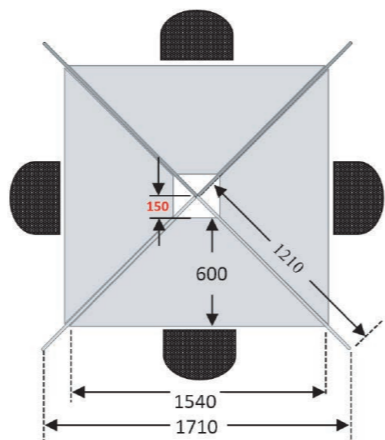
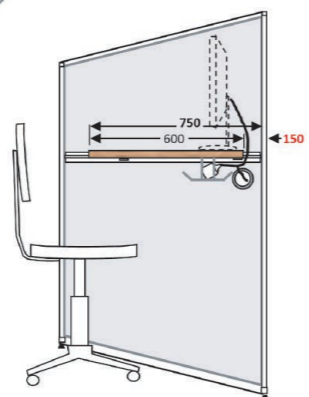
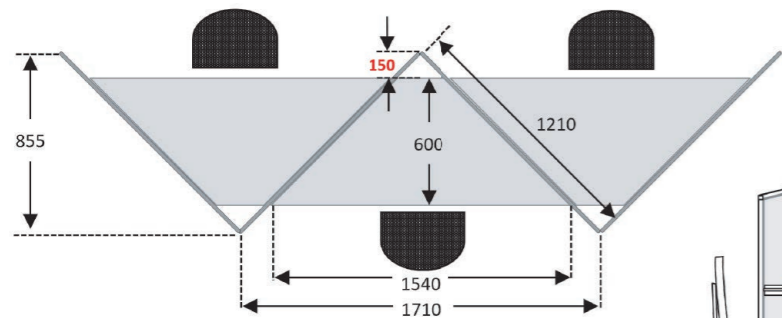

Rail aluminium pour fixation plateau ou accessoires (voir page 40). A intégrer dans la cloison.

Aluminum profile for desk surfaces or accessories (see page 40). To be integrated into the screen.

Alu-Profil für Tischplatten-Befestigung oder Zubehör (siehe Seite 40). In die Wand einzulassen.

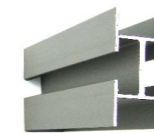
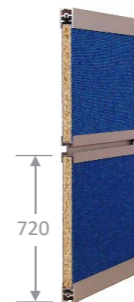

Ref. MVH 100/ 610
Ref. MVH 100/ 810
Ref. MVH 100/ 1010
Ref. MVH 100/ 1210
Ref. MVH 100/ 1410
Ref. MVH 100/ 1610
Ref. MVH 100/ 1810

4 Supports pour plateau

4 Holders for desk surfaces

4 Halter für Tischplatte



Ref. MVH 110

Plateau mélaminé blanc ou gris 28mm + 4 supports MVH 110

28mm thick white or grey desk surface + 4 holders MVH 110

28mm Melamin Tischplatte weiss oder grau + 4 Halterungen MVH 110



Ref. MVH 600 x TRAP

Prise compact type E avec chargeur USB 5V / 2,4A

E type compact desk power plug with 5V / 2,4A USB charger

Kompakte Typ E Schreibtischsteckdose mit USB-Ladefunktion 5V / 2,4A



Ref. MVH 213

Goulotte pour câbles longueur 420mm à fixer sous le plateau

Cable support 420mm long to fix under the desk surface

Kabelwanne 420mm lang unter Tischplatte zu befestigen

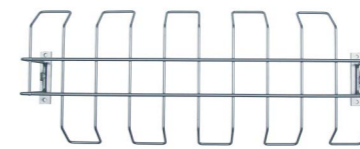

Ref. MVH 212

Passage pour câbles (à prévoir à la commande)

Cable pathway (to be specified when ordered)

Kabeldurchführung (Bei Bestellung angeben)

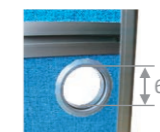
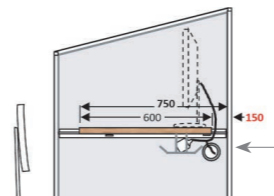

Ref. MVF 111

 **POSTES DE TRAVAIL
+ CALL CENTER**

 **WORKSTATIONS
+ CALL CENTER**

 **ARBEITSPLÄTZE
+ CALL CENTER**

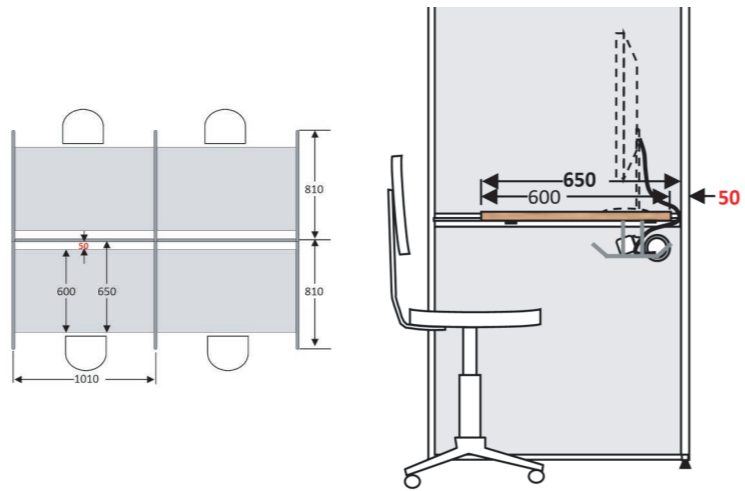
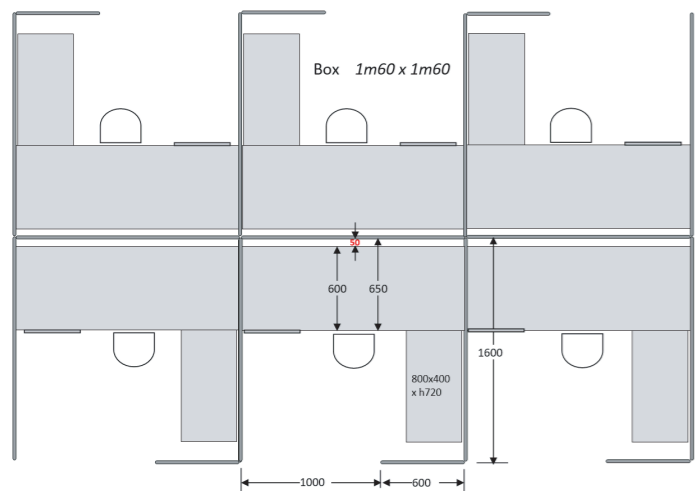

Rail aluminium pour fixation plateau ou accessoires (voir page 40).
A intégrer dans la cloison.

Aluminum profile for desk surfaces or accessories (see page 40).
To be integrated into the screen.

Alu-Profil für Tischplatten-Befestigung oder Zubehör (siehe Seite 40).
In die Wand einzulassen.

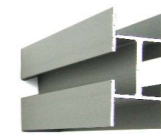
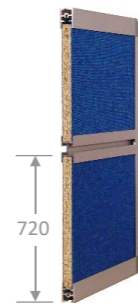

- Ref. MVH 100/ 610
- Ref. MVH 100/ 810
- Ref. MVH 100/ 1010
- Ref. MVH 100/ 1210
- Ref. MVH 100/ 1410
- Ref. MVH 100/ 1610
- Ref. MVH 100/ 1810

4 Supports pour plateau

4 Holders for desk surfaces

4 Halter für Tischplatte



Ref. MVH 110

Plateau mélaminé blanc ou gris
28mm + 4 supports MVH 110

28mm thick white or grey
desk surface + 4 holders MVH 110

28mm Melamin Tischplatte weiss
oder grau + 4 Halterungen MVH 110



- Ref. MVH 600 x 800
- Ref. MVH 600 x 1000
- Ref. MVH 600 x 1200
- Ref. MVH 600 x 1400
- Ref. MVH 600 x 1600

Prise compact type E
avec chargeur USB 5V / 2,4A

E type compact desk power plug
with 5V / 2,4A USB charger

Kompakte Typ E Schreibtischsteckdose
mit USB-Ladefunktion 5V / 2,4A



Ref. MVH 213

Goulotte pour câbles longueur
420mm à fixer sous le plateau

Cable support 420mm long to fix
under the desk surface

Kabelwanne 420mm lang unter
Tischplatte zu befestigen

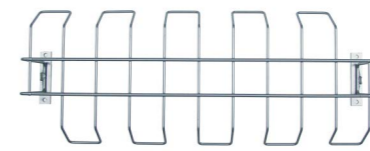

Ref. MVH 212

Passage pour câbles
(à prévoir à la commande)

Cable pathway
(to be specified when ordered)

Kabeldurchführung
(Bei Bestellung angeben)

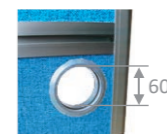
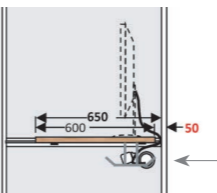

Ref. MVF 111



**REHAUSSE +
ÉCRAN EN VERRE**



**GLASS DESK
SCREEN + TOPPER**



**GLAS-
WÄNDE + AUFSATZ**



Rehausse en verre
trempé dépoli 5mm
5mm frosted tempered glass
(securit)
Aufsatz aus gehärtetem Mattglas
5mm stark (securit)

Ref. MGD 250/ 790
Ref. MGD 250/ 990
Ref. MGD 250/ 1190
Ref. MGD 250/ 1390
Ref. MGD 250/ 1590
Ref. MGD 250/ 1790

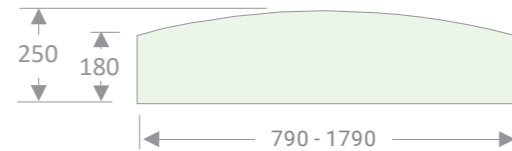

Clip pour verre
de 4 à 10mm avec écrou
Clip for 4 to 10mm glass
with nut
Klip für 4 bis 10mm starkes Glas
mit Mutter

Ref. MVU 002

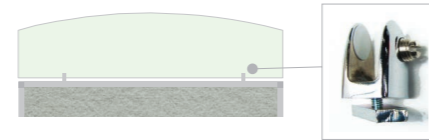

Ecrans en verre
trempé dépoli 5mm
Glass desk screens
5mm frosted tempered glass
Glaswände
aus gehärtetem Mattglas 5mm stark

Ref. MGD 450/ 790
Ref. MGD 450/ 990
Ref. MGD 450/ 1190
Ref. MGD 450/ 1390
Ref. MGD 450/ 1590
Ref. MGD 450/ 1790

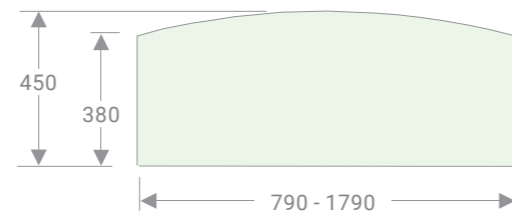

Pince bureau métallique
+ clip pour verre de 4 à 10mm
Metal desk clamp
+ clip for 4 to 10mm glass
Tischklammer
+ Klip für Glas von 4 bis 10mm

Ref. MVM 280
Ref. MVM 380

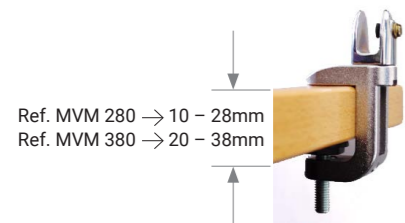

 **ACCESSOIRES**

 **ACCESSORIES**

 **ZUBEHÖR**



Rail aluminium pour accessoires sur les 2 faces de la cloison. A prévoir à la fabrication.
Aluminium profile for accessories on both sides of the screen. Must be specified prior to manufacture.
Alu-Profil für Zubehör an beiden Seiten der Trennwand. Bei der Herstellung einzuplanen.

Plaque pour fixation accessoires 350 x H 330mm
 A enclencher sur le profilé haut de la cloison.
Accessory plate 350 x H 330mm, interlocks on to the aluminum profile of the screen.
Platte zur Befestigung von Zubehör 350 x H 330mm, zum einrasten am oberen Profil der Trennwand.

Bac à Courrier 335 x 250 x 50mm
Paper tray 335 x 250 x 50mm
Ablagefach 335 x 250 x 50mm

Pot à crayon
Pen holder
Stift-Cup

Support tablette ou téléphone 80 x 60mm
Tablet or cell phone holder 80 x 60mm
Tablet- / Mobiltelefon-Halterung 80 x 60mm

Support inclinable et orientable pour écran LCD de 10 à 23"
 Peut être fixé directement sur la cloison avec vis traversantes ou sur la plaque Ref. MVH 200.
10-23" LCD monitor mount full rotation
 Can be fixed directly on the screen with screws through the panel or on the plate Ref. MVH 200.
Neig- und schwenkbare Halterung für 10-23" LCD-Monitor
 Kann direkt an der Wand mit durchgehenden Schrauben oder an der Platte Ref. MVH 200 befestigt werden.

Ref. MVH 100/ 610
 Ref. MVH 100/ 810
 Ref. MVH 100/ 1010
 Ref. MVH 100/ 1210
 Ref. MVH 100/ 1410
 Ref. MVH 100/ 1610
 Ref. MVH 100/ 1810

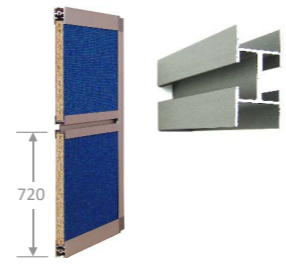

Ref. MVH 200



Ref. MVH 201

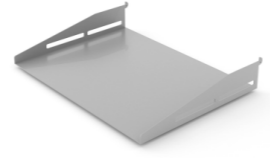

Ref. MVH 204



Ref. MVH 206



Ref. MVH 209



Crochet métallique



Crochet porte manteau



Profilé d'obturation en PVC souple gris



Sabot à poser sur le bureau
 Prix unitaire



Metal hook



Coatrack hook

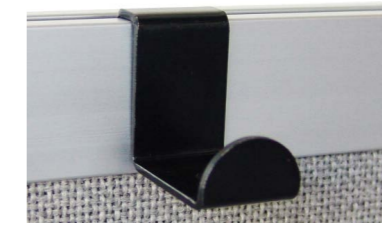

Shutterprofile flexible grey PVC



Base to place on the desk
 Unit price

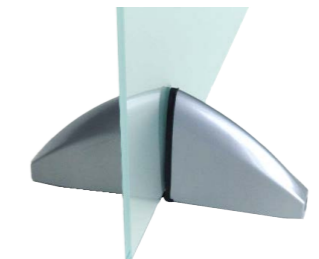

Metalhaken

Ref. MVD 200

Kleiderhaken

Ref. MVC 111

Verstopfprofile aus grau Weich-PVC

Ref. MVX 001

Sockel auf den Tisch zu lege
 Stückpreis



Ref. MVZ 200



**SOLUTIONS
ACOUSTIQUES**



**ACOUSTIC
SOLUTIONS**



**AKUSTISCHE
LÖSUNGEN**

Panneaux suspendus et muraux
Super-Acoustique
Tests acoustiques page 17

Hanging and wall panels
Super-Acoustic
Acoustic tests page 17

Hänge- und wandpaneele
Super-Akustik
Akustikteste Seite 17



Hauteur
Height
Höhe

1000 mm

1200 mm

1400 mm

1600 mm

- Ref. ATT 1000 x 600
- Ref. ATT 1000 x 800
- Ref. ATT 1000 x 1000
- Ref. ATT 1000 x 1200
- Ref. ATT 1000 x 1400
- Ref. ATT 1000 x 1600

- Ref. ATT 1200 x 600
- Ref. ATT 1200 x 800
- Ref. ATT 1200 x 1000
- Ref. ATT 1200 x 1200
- Ref. ATT 1200 x 1400
- Ref. ATT 1200 x 1600

- Ref. ATT 1400 x 600
- Ref. ATT 1400 x 800
- Ref. ATT 1400 x 1000
- Ref. ATT 1400 x 1200
- Ref. ATT 1400 x 1400
- Ref. ATT 1400 x 1600

- Ref. ATT 1600 x 600
- Ref. ATT 1600 x 800
- Ref. ATT 1600 x 1000
- Ref. ATT 1600 x 1200
- Ref. ATT 1600 x 1400

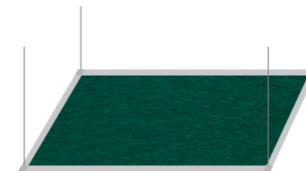

Fixation pour panneaux suspendus
cables longueur réglable
(maximum 2 m) vendus par deux

Fixing for hanging panels
Adjustable length cables
(maximum 2 m) sold by two

Befestigung für Hängepaneele
Kabel mit einstellbarer Länge
(maximal 2 m) zu zweit verkauft

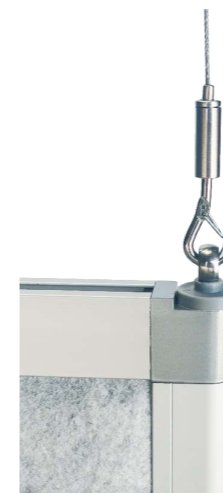

Vertical
1 x APD



Horizontal
2 x APD



Ref. APD

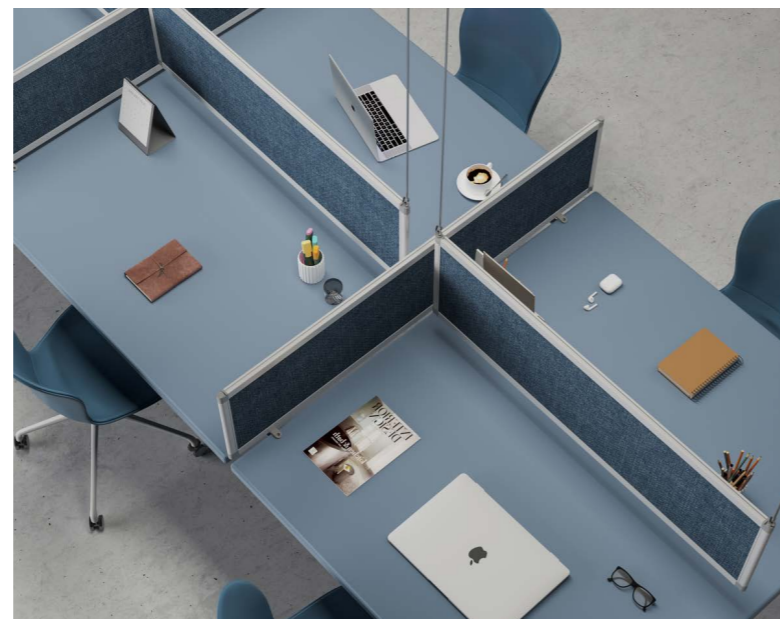

Fixation pour panneaux muraux

Fixing for wall panels

Befestigung für Wandpaneele

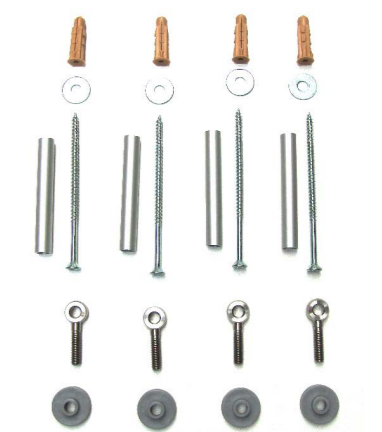
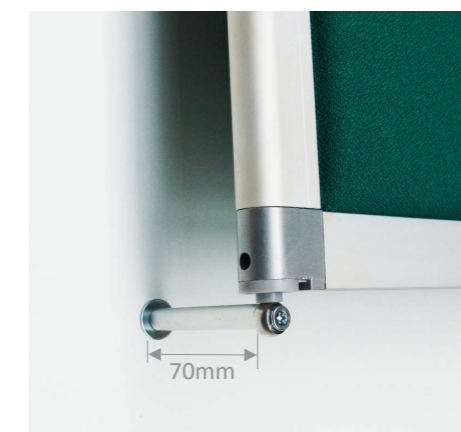

Ref. APM



 **CLOISONS MOBILES
À ANGLE DROIT**

 **FREESTANDING
ANGLE PARTITIONS**

 **BEWEGLICHE
ECKTRENNWÄNDE**



Les panneaux mobiles à angle droit se rangent facilement dans un coin.
The angle partitions can easily be stored in a room corner.
Die bewegliche Trennwände können einfach in einer Ecke eingestellt werden.

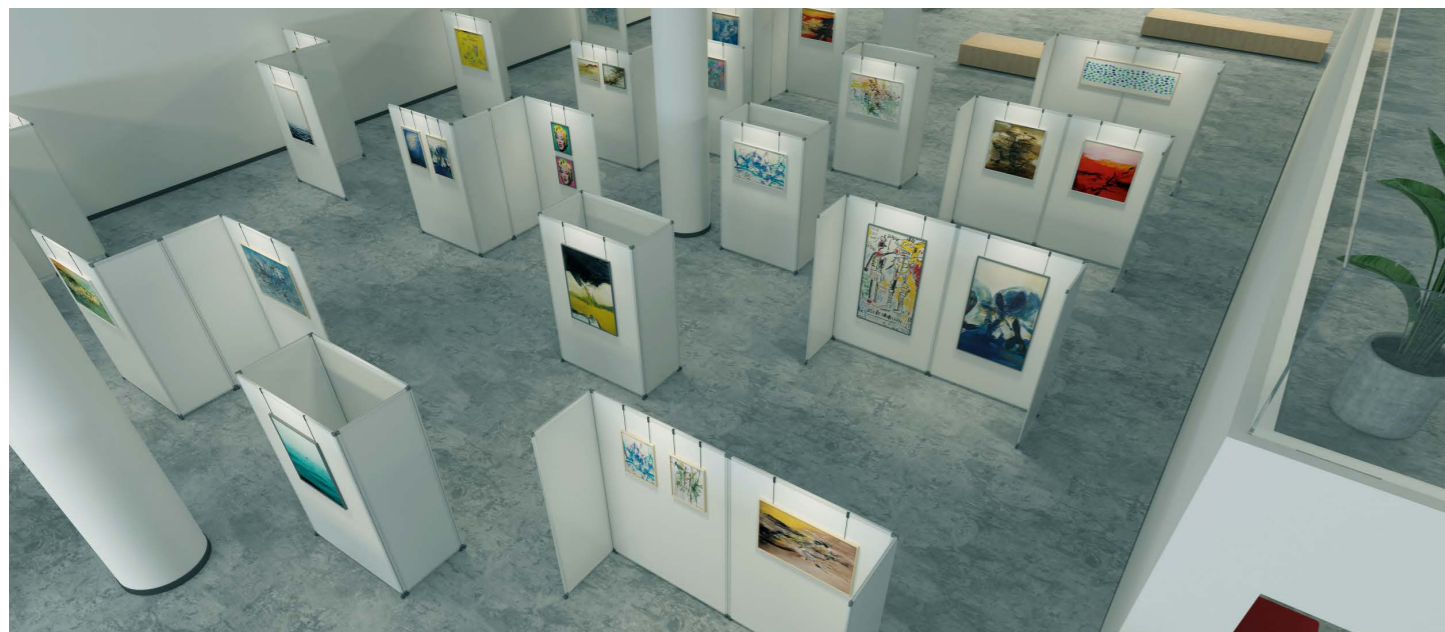

Les Cloisons Reyem à angle droit sur 3 roulettes permettent de séparer rapidement vos espaces, peuvent être utilisées dans des salles polyvalentes, musées, expositions...

The three-castor free-standing partitions by Reyem are a fast and easy solution to separate your spaces. They can be used in function rooms, museums, exhibitions and many other locations...

Die rechtwinkligen Reyem Trennwände auf 3 Rollen ermöglichen Ihnen eine schnelle Raumteilung und können in Mehrzweckhallen, Museen, Ausstellungsräumen usw. eingesetzt werden.

- ✓ **BONNE STABILITE**
- ✓ **FACILE A DEPLACER ET A ASSEMBLER**
- ✓ **GAIN DE PLACE LORS DU RANGEMENT**

- ✓ **A STABLE SOLUTION**
- ✓ **EASY TO TRANSPORT AND ASSEMBLE**
- ✓ **SAVE VALUABLE STORAGE SPACE**

- ✓ **GUTE STABILITÄT**
- ✓ **EINFACH BEWEGBAR & ZUSAMMENBAUBAR**
- ✓ **PLATZSPAREND VERSTAUBAR**

Ensemble de deux cloisons + kit 3 roulettes
Mélaminé blanc de 8 mm

Pour d'autres coloris ou PVC blanc de 8 mm classé feu **M1 / B, s3, do** veuillez nous consulter.

Two partitions + 3 castor kit
8mm white melamine

For other colours, or 8mm white PVC with fire safety classification **B, s3, do**, please contact us.

Einheit aus zwei Trennwänden + 3 Rollen satz
8 mm weiß Melamin

Für andere Farbe, oder 8 mm Weiß PVC, Feuersicherung Class **B, s3, do**, kontaktieren Sie uns.

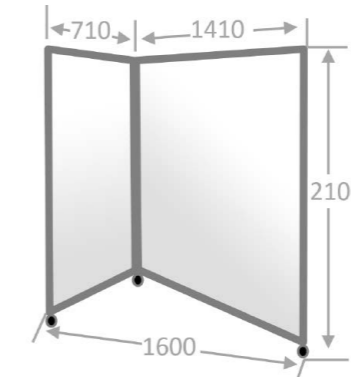

Ref. PAS 2100 1410 / 710



Roulettes avec frein
Locking castors
Rollen mit Bremsfunktion

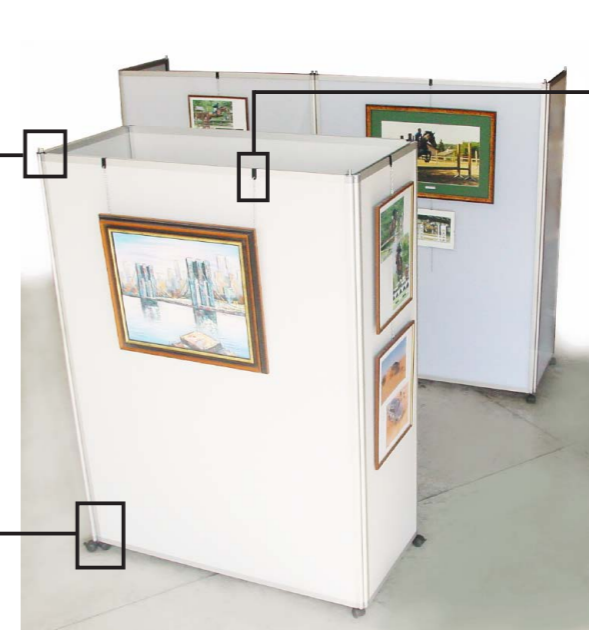

Crochet métallique
Metal hook
Metalhaken
Ref. MVD 200



Kit 3 roulettes uniquement
3 castor kit only
Einzel 3 Rollensatz
Ref. EP 57



CONDITIONS DE TRANSPORT

Frais de port et d'emballage pour la **ZONE A** :

Pour une commande prix tarif :
de 0 à 1 500 € = **100 €**
de 1 501 à 3 000 € = **50 €**
supérieur à 3 001 € = **FRANCO**

Frais de port et d'emballage pour la **ZONE B** :

Pour une commande prix tarif :
de 0 à 1 500 € = **120 €**
de 1 501 à 3 000 € = **60 €**
supérieur à 3 001 € = **FRANCO**

Frais de port et d'emballage pour les **AUTRES DESTINATIONS**, veuillez nous consulter.



CONDITIONS OF TRANSPORT

Shipping and packing costs for **ZONE A**:

For an order:
between €0 and €1500 price list = **€100**
between €1501 and €3000 price list = **€50**
over €3001 price list = **FREE DELIVERY**

Shipping and packing costs for **ZONE B**:

For an order:
between €0 and €1500 price list = **€120**
between €1501 and €3000 price list = **€60**
over €3001 price list = **FREE DELIVERY**

Shipping and packing costs for **OTHER DESTINATIONS**, please contact us.



BEFÖRDERUNGS-BEDINGUNGEN

Porto- und Verpackungskosten für die **ZONE A**:

Für eine Bestellung:
von 0 bis 1 500 € Listenpreis = **100 €**
von 1 501 bis 3 000 € Listenpreis = **50 €**
ab 3 001 € Listenpreis = **PORTOFREI**

Porto- und Verpackungskosten für die **ZONE B**:

Für eine Bestellung:
von 0 bis 1 500 € Listenpreis = **120 €**
von 1 501 bis 3 000 € Listenpreis = **60 €**
ab 3 001 € Listenpreis = **PORTOFREI**

Porto- und Verpackungskosten für **ANDERE LANDER**, bitte kontaktieren Sie uns.

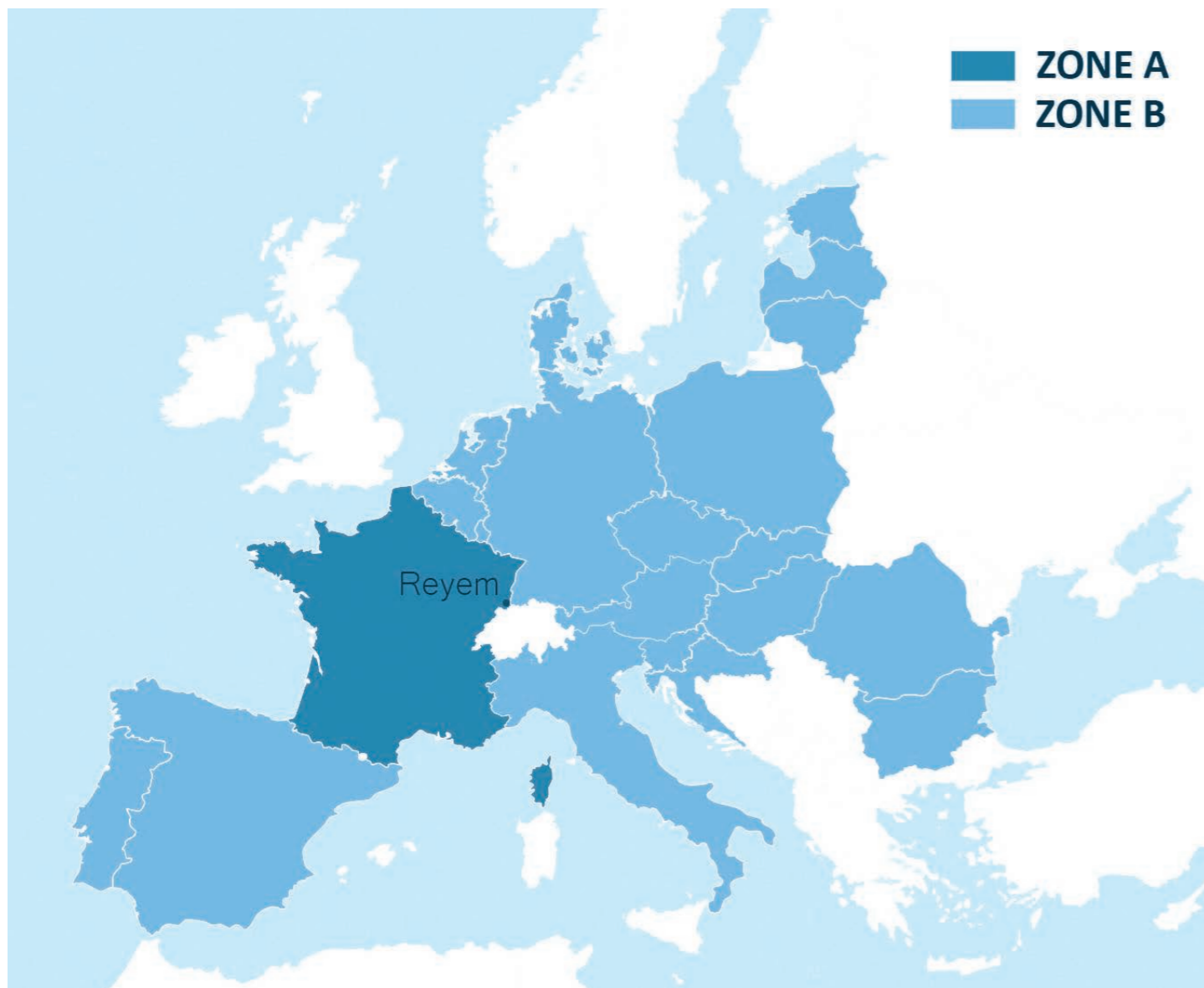

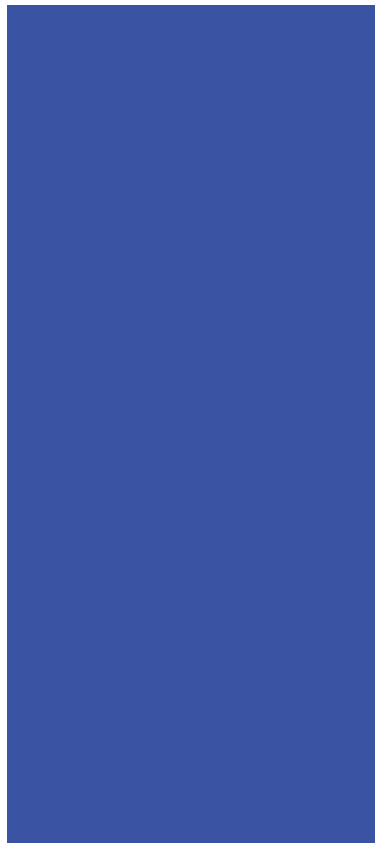

Reyem S.A.S.

ZA DE LA SAVONNERIE
FR-68460 LUTTERBACH
FRANCE

TEL : +33 (0)3 89 57 20 11
reyem@reyem.com



Reyem DEUTSCHLAND

UELLENDÄHLER STRASSE 27-29
DE-42107 WUPPERTAL
DEUTSCHLAND

TEL: +49 (0) 2053 9979395
sales@reyem.com

www.reyem.com

Available on **pCon**
PLANNER

FR

Vous pouvez réaliser vos plans, implantations
3D ou chiffrages gratuitement sur le logiciel
pCon planner.

EN

You can create your plans, 3D layouts or
quotations for free using pCon planner software.

DE

Mit der Software pCon Planner erstellen Sie
kostenfrei Ihre Pläne, 3D-Layouts oder Angebote.